

SIEMENS



SINAMICS Drives

Medium Voltage Drives

**SINAMICS PERFECT HARMONY
GH180**

Catalog
D 17

Version 3.5
12/2023

innomotics.com/sinamics-perfect-harmony-gh180

Information about Publisher and Ownership of the Document

The following pages contain the Siemens logo and the Siemens legal information.

Please note that since July 1st, 2023 the Siemens Businesses **Large Drives Applications** and **Low Voltage Motors** are part of **Innomotics GmbH**, Germany.

All rights to and product information on the following pages have been transferred from Siemens to Innomotics.

The re-branding of the document will take place in due course.

Publisher information:

Innomotics GmbH
Vogelweiherstrasse 1-15
D - 90441 Nuernberg
Germany

© Innomotics GmbH 2023

INNOMOTICS





A Siemens Business



Contents

SINAMICS medium voltage drives	4
Overview	5
SINAMICS medium voltage drives: always the right solution	6
SINAMICS PERFECT HARMONY GH180 air- and water-cooled drives	7
SINAMICS PERFECT HARMONY GH180 benefits	8
SINAMICS PERFECT HARMONY GH180 design	10
PERFECT HARMONY GH180 cell bypass evolution	12
SINAMICS PERFECT HARMONY GH180 solutions	13
Options	21
Availability by manufacturing location	21
Option descriptions	26
Article number structure	46
Technical data	50
General technical data	50
Storage, transportation and operation data	53
Air-cooled technical data	54
Air-cooled dimension drawings	69
Water-cooled technical data	73
Water-cooled dimension drawings	76
Engineering information	77
Control performance	77
Protection and monitoring functions	79
Interfaces	80
Air cooling requirements	81
Water cooling requirements	82
Current product information	84
Siemens Product Configurator and other engineering tools	84
Services for Large Drives Applications	85
SIDRIVE IQ	87
Scope of Supply	88
Recommended List of Spare Parts	88

SINAMICS medium voltage drives

One single topology or drive configuration does not fit all applications. This is the reason Siemens offers drives featuring six different technologies, motor voltage classes from 2.3 kV to 13.8 kV and power ratings from 150 kW to 85 MW. Plus, the drive systems match perfectly with Siemens high-voltage motors to provide you with unparalleled levels of reliability, availability, flexibility and performance.

	SINAMICS PERFECT HARMONY GH180	SINAMICS PERFECT HARMONY GH150	SINAMICS GM150	SINAMICS GL150
Technical Specifications				
Type of converter	Multi-cell voltage source inverter featuring H-Bridge Perfect Harmony technology (H-Bridge VSI)	Multi-cell voltage source inverter featuring Modular multilevel converter technology (M2C VSI)	3-level Neutral Point Clamped voltage source inverter with Diode Front End (3L NPC DFE)	Current Source inverter with load-commutated inverter technology (LCI)
Converter cooling	Air (A), water (W)	Air (A), water (W)	Air (A), water (W)	Air (A), water (W)
Power range	A: 0.15 to 17 MVA W: 3.5 to 48.8 MVA	A: 4 to 70 MVA W: 4 to 47 MVA	A: 1-10.1 MVA W: 2-24 MVA	A: 1-30 MVA W: 6-85 MVA (higher on request)
Transformer	Integrated transformer	Separate transformer	Separate transformer	Separate transformer
Rectifier section	A: 2Q (DFE), 4Q W: 2Q (DFE), 4Q	2Q (DFE)	2Q (DFE)	4Q
Output voltage	A: 2.3 to 11 kV W: 2.3 to 11 kV	A: 4 to 13.8 kV W: 4 to 11 kV	2.3 to 4.16 kV 6.6 kV (tandem)	1.4 to 10.3 kV

	SINAMICS SH150	SINAMICS SM150	SINAMICS SL150
Technical Specifications			
Type of converter	Multi-cell voltage source inverter featuring Modular multilevel converter technology (M2C VSI) with Active Front End (AFE)	3-level Neutral Point Clamped voltage source inverter with Active Front End (3L NPC AFE)	Cycloconverter (CC)
Converter cooling	Water (W)	Air (A), water (W)	Air (A), water (W)
Power range	W: 3 to 16 MVA	A: 3.4 to 5.8 MVA W: 4.6 to 31.5 MVA	A: 3 to 18.8 MVA W: 3 to 40 MVA
Transformer	Separate transformer	Separate transformer	Separate transformer
Rectifier section	2Q (DFE) or 4Q (AFE)	2Q (DFE) or 4Q (AFE)	4Q
Output voltage	3.3 to 7.2 kV	IGBT: 3.3 to 4.16 kV IGCT: 3.3 kV	A: up to 3.3 kV W: up to 4.0 kV

Overview

Siemens has more than four decades of experience manufacturing nearly every type of medium-voltage converter or inverter that exists today. We have chosen our portfolio of drives to meet your specific needs with the optimal solution for every type of medium-voltage application:

- Standard applications such as pumps, fans, compressors and conveyors
- Specialized applications such as rolling mills, horizontal mills, shaft generators and high-speed compressors

	SINAMICS PERFECT HARMONY GH180	SINAMICS PERFECT HARMONY GH150	SINAMICS GM150	SINAMICS GL150	SINAMICS SH150	SINAMICS SM150	SINAMICS SL150
Pumps	X	X	X	X			
Fans	X	X	X	X			
Conveyors (downhill)	X				X	X	X
Conveyors (uphill)	X	X	X				X
Crushers	X		X				
Extruders	X		X	X			
Mixers	X		X				
Compressors	X	X	X	X	X		
Excavators			X				X
Kilns	X						
High-pressure grinders	X		X				
Vertical mills	X		X				
Horizontal mills (geared)	X		X			X	X
Horizontal mills (gearless)							X
Existing line motors	X	X		X	X		
Blast furnace blowers	X	X	X	X			
Pump storage	X			X	X		
Rolling mills						X	X
Propulsion		X	X	X	X		
Thrusters			X				
Mine winders						X	X
Boiler feed pumps	X	X	X	X			
Starting generators				X			
Starting blast furnace blowers				X			
Onshore power supply					X		
Test stands	X	X		X	X	X	
Shaft generators				X	X		X
Shaft generator / booster				X	X		
LNG start / helper (all-electric)	X	X		X	X		
ESP applications	X						
Permanent magnet motors	X	X					

SINAMICS medium voltage drives: always the right solution

SINAMICS frequency converters - drives for every drive application

Siemens is the leading manufacturer of electric drive technology. With SINAMICS frequency converter technology, you can address each and every drive application – whether low voltage, medium voltage or DC. You can operate synchronous motors as well as induction motors according to the characteristics of the machine you are driving. Our variable frequency drives, electric motors and control systems for the variable-speed control of machines are perfectly coordinated with one another and can be very simply integrated into your existing system and automation landscape.

Discover why no other drive portfolio can match the flexibility and performance of our SINAMICS medium voltage drives. With systems in motor voltage classes from 1.4 kV to 13.8 kV, and power ratings from 100 kW to 85 MW, Siemens drives are built to provide the reliability, longevity and quality that modern applications demand – because in today's competitive market, downtime is not an option. Due to complex project requirements, it is always recommended that users contact their Siemens sales partner for more advanced assistance in selecting the correct drive for the application. Designed to save energy, reduce operating costs and reinforce reliability, SINAMICS VFDs are the industry's preferred choice in power conversion:

- Wide range of input voltage capability: from 480 V to 35 kV
- Wide range of output voltage capability: from 1.4 to 13.8 kV
- A seamless range of power ratings: from 100 kW to 85 MW
- Single-motor drives and multi-motor systems
- Oldest motor retrofitted – 1942 (68 years old at time of retrofitting)
- Motor speeds from 7 to 15,900 rpm
- Operates induction, wound rotor, synchronous, permanent magnet, slipring and super-conducting motors

Strong foundation

For decades, Siemens has offered our customers medium voltage drives with the highest degree of reliability and availability in the world.

More than 50 years of experience, power of innovation and comprehensive knowledge have enabled Siemens to become the trusted name in the medium voltage drive arena.

- 1969: Develops variable-speed medium voltage drive systems with current-source DC link
- 1970: Introduces Cycloconverter for low speed applications
- 1994: Revolutionizes medium voltage drives with cell-based topology of ROBICON Perfect Harmony
- 1995: Launches SIMOVERT ML for rolling mill applications
- 1998: Pioneered the use of high-voltage IGBTs for medium voltage drives
- 2003: Produces the highest-rated high-speed drive (LCI) for an LNG compressor (65 MW)
- 2005: Launches water-cooled 4Q technology
- 2013: Launches SINAMICS SM120 CM – first medium voltage drive featuring M2C technology
- 2014: Launches SINAMICS GH150 – general purpose medium voltage drive featuring M2C technology
- 2020: Reaches 20,000+ SINAMICS PERFECT HARMONY GH180 drives installed worldwide
- 2021: Launches air-cooled 4Q offering

Proven technology

Based on well-proven technological concepts, Siemens is continually improving our medium voltage drives. The result: increasingly higher reliability and operational reliability and safety, more compact types of construction, reduced energy requirements, lower service and maintenance costs, as well as simpler handling from engineering through to installation, integration and commissioning up to operator control. With an installed base exceeding more than 35 GW worldwide, the SINAMICS PERFECT HARMONY GH180 is a proven workhorse that can perform brilliantly for you, too.



SINAMICS PERFECT HARMONY GH180 air- and water-cooled drives

Technical characteristics

Air-cooled drives



Water-cooled drives



The SINAMICS PERFECT HARMONY GH180 drive family consists of core design configurations, where they are functionally identical and share a common controller. These designs are targeted at distinct output power configurations with little overlap between the frame sizes. The SINAMICS PERFECT HARMONY GH180 family is summarized in the tables below.

SINAMICS PERFECT HARMONY GH180 characteristics at a glance

Line-side rectifier		6SR5 6SR327	24 to 54 pulse diode rectifier 18 to 48 pulse diode rectifier
Motor-side inverter			Multilevel drive (PWM)
Power cells	A	6SR5 6SR327	40, 70, 100, 140, 200, 260, 340, 430, 550, 600, 720, 750 880, 1000, 1250, 1375
Input voltage range	kV	6SR5 6SR327	480 V to 13.8 (higher input voltage on request) 2.3 to 13.8
Input voltage tolerance			+10 %, -10 % ¹⁾ of nominal rated input voltage
Input overvoltage (swell)			+20 %
Input undervoltage (dip or sag)			-34 %, continues operation with reduced torque
Medium voltage ride through			500 ms – 2Q only (30 cycles @ 60 Hz and 25 cycles @ 50 Hz)
Input frequency	Hz		50/60 ± 5 %
Input power factor			≥ 0.95 above 10 % load
Input harmonics			≤ 3 % total demand distortion (TDD) ²⁾
Output voltages	kV	6SR5 6SR327	2.3/2.4, 3.3, 4.0/4.16, 4.6/4.8, 6.0, 6.6, 6.9/7.2, 10.0, 11.0 3.3, 4.0/4.16, 4.6/4.8, 6.0, 6.6, 6.9/7.2, 10.0, 11.0
Output frequency and drift	Hz		0.5 ... 330 ± 0.5 % (sensor-less or open loop vector control), or ± 0.1 % with encoder (encoder or closed loop vector control)
Output Torque			100 % from 10 to 167 Hz without derating ³⁾
Drive quadrants			2 or 4
Power range	hp	6SR5 6SR327	150 to 17000 (100 kW to 12.7 MW) 4000 to 33000 (3 to 24.6 MW)
Overload	1min/ 10min	6SR5 6SR327 ⁴⁾	110 % built-in, 150 % available as an option, higher on request 110 % built-in, 150 % available as an option, higher on request
Drive Control methods			Sensor-less or open loop vector control, encoder or closed loop vector control, volts-hertz control
Motor control			Induction, Synchronous, Permanent magnet motors, and Wound rotor motors

1) ±10 % of nominal depending on tap. Output power derating required for -5 to -10 % voltage tolerances

2) As measured at the drive input, actual performance at the site will depend on the present harmonic distortion

3) Proper drive sizing is required. When derated properly, the drives are available for low frequency (0.5 to 10 Hz) and high frequency (168 to 330 Hz) with de-rated torque.

4) 6SR327 drives with 1000 and 1375 A are only available with 100 % rated current.

SINAMICS PERFECT HARMONY GH180 benefits

Clean input power

The SINAMICS PERFECT HARMONY GH180 drive:

- Meets the most stringent IEEE 519-2014 requirements for voltage and current harmonic distortion, even if the source capacity is no larger than the drive rating¹⁾:
 - The SINAMICS PERFECT HARMONY GH180 drive is supplied with a minimum 18-pulse input with versions available up to 54-pulse input, resulting in less than 3 percent total voltage distortion and less than 3 percent total current distortion. It eliminates the need for costly and inefficient harmonic filters and the associated resonance problems.
- Protects other online equipment from harmonic interference (computers, telephones and other power converters)

Sinusoidal output power (waveforms)

The SINAMICS PERFECT HARMONY GH180 drive:

- Minimizes drive induced torque pulsations and associated torsional analysis compared to other medium voltage topologies, by using a motor friendly pulse width modulation (PWM) output:
 - Less than 1 % induced torque ripple for any given frequency results in no motor heating and no bearing wear
- Note:
For certain motor voltages the torque ripple value can go up to 3 %, but only at relative speeds above 95 %.
- Eliminates additional losses due to harmonics; thus, it can be used with new or existing motors without de-rating:
 - Depending on configuration generates 13 to 33 level output waveform line to line
 - Small output voltage steps produce no voltage spikes at the motor which allows the use of a motor with standard insulation
 - No need for filters up to 7500 ft (2.3 km)
 - Waveforms remain high quality at lower speeds due to multi-level PWM output



Maximized availability

The SINAMICS PERFECT HARMONY GH180 drive:

- Remains operational in the event of a cell failure by using the cell bypass option which bypasses the faulted cell
- Achieves near 100 percent reliability and 99.99 percent availability, delivers greater productivity and a significantly reduced total cost of ownership over the drive's life cycle
- Offers a Process Tolerant Protection Strategy (ProToPS™). ProToPS™ protects customer process from faulty sensors or data. Unlike typical systems that simply trip the drive and shut down the system due to a malfunction, it offers a proactive control approach based on a hierarchical warning system that allows the operator to evaluate the drive and system condition and respond appropriately or initiate controlled shutdown.

Extended reliability

The SINAMICS PERFECT HARMONY GH180 drive with an integrated transformer provides the following advantages:

- Protects drive semiconductors from line transients
- Completely protects the motor in case of a ground fault in the converter, the motor cabling or insulation

Exceptional input line performance

Robust design provides immunity from most input power disturbances and interruptions to insure protection of customer equipment and trip free operation during most common and frequent power quality issues:

- Best in class input voltage brownout conditions - no trip down to 66 percent of nominal voltage. Output power is reduced by limiting the available motor torque, drive can operate continuously in this mode
- When the line voltage drops below 66 percent, it results in "Ride Through Mode / Power Loss Ride Through" of up to 500 ms – 30 cycles @ 60 Hz and 25 cycles @ 50 Hz systems. (Not available for 4Q drives.)
- Built-in input transformer with lightning arrestors to provide protection from excessive peak voltage

Over 25 years of performance and more than 21,000 units in operation exceeding 35 million kW installed power worldwide, Siemens has only one goal in mind: optimizing customer profitability

1) IEEE 519-2014 compliance can only be guaranteed in networks without prior disturbances or harmonics already present.

Extensive testing

SINAMICS PERFECT HARMONY GH180 will get your process up and running because we have the ability to test every product at full load – prior to delivery:

- At our factory, we test every transformer and power converter together to ensure performance meets precise specifications.
- We verify sequence of operation and protection to ensure that the SINAMICS PERFECT HARMONY GH180 drive matches your needs.
- As an option, factory testing allows accurate efficiency measurements if customer requests it.

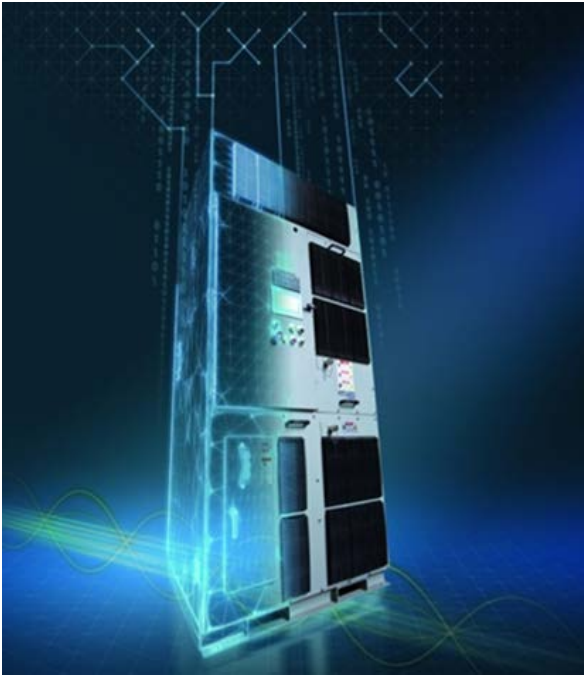

*SINAMICS PERFECT HARMONY GH180 –
The most proven medium-voltage drive
on the market today with a cell-based
design perfect for meeting high efficiency
and availability application requirements.*

Ease of installation and maintenance

SINAMICS PERFECT HARMONY GH180 drives are easy to install and maintain:

- Customer provides three cables in and three cables out. There is no customer site cabling required to connect the drive sections.
- Power cells can be removed easily for maintenance due to their reduced weight and front accessible connections.
- With optional Advanced Cell Bypass a faulty cell can be changed out at a later date in 30 minutes or less.
- Sophisticated microprocessor-based diagnostics pinpoint the location of any defects

SINAMICS PERFECT HARMONY GH180 design

Drive topology

The SINAMICS PERFECT HARMONY GH180 series drives achieve an uncompromising performance by employing well-proven technology in a modular configuration, as shown in Figure 1. Medium voltage levels are obtained by adding together the outputs of multiple power cells. The power cells are simplified variations of standard 2-level PWM low voltage drives, which have been built in high volume for many years.

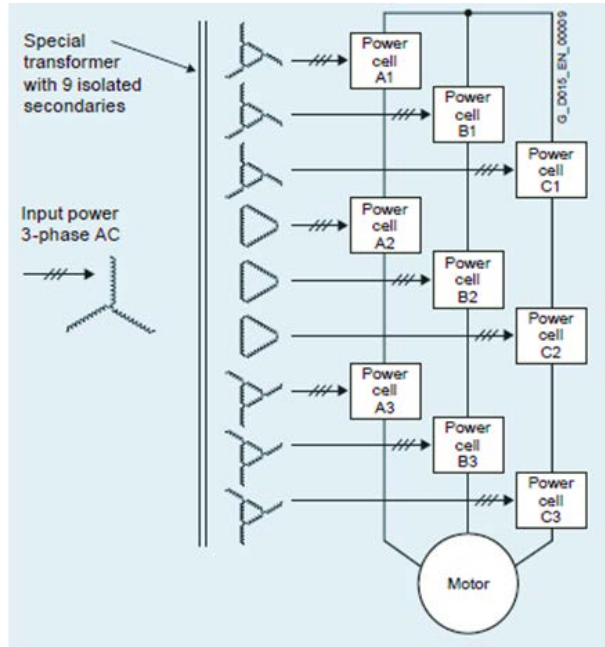

Figure 1: Topology of SINAMICS PERFECT HARMONY GH180 drive (3 cells per phase)

For higher output voltage capabilities, the SINAMICS PERFECT HARMONY GH180 topology can be extended up to eight power cells in series in each phase, with additional secondary windings (number of secondaries equals number of power cells) on the integral isolation transformer.

Transformer

Since the early 1990s, Siemens has collaborated extensively with transformer suppliers to perfect the design of the transformers used in each SINAMICS PERFECT HARMONY GH180 drive. The patented design provides several benefits in the drive topology, including the adaptability to input voltage, a multi-pulse input, and a reduction in common mode voltage.

The transformers used in the SINAMICS PERFECT HARMONY GH180 are VPI dry-type, forced-air or water-cooled. They are designed specifically for use with a particular SINAMICS PERFECT HARMONY GH180 drive configuration and have 9 to 24 extended delta secondaries.

The SINAMICS PERFECT HARMONY GH180 transformers are designed, constructed, and tested as per IEC 60076-11 standard. The transformer is an integral part of the drive that cannot be specified or obtained externally to Siemens.

Proven IGBTs

Low voltage Insulated Gate Bipolar Transistors (IGBTs) form the backbone of the SINAMICS PERFECT HARMONY GH180 drive. Built in high volumes and serving as a proven power device across the industrial power control industry, IGBT technology has been in existence for more than two decades. The stability and availability of IGBTs give reliable, long-term, lifecycle confidence.

Linked power cells

In the SINAMICS PERFECT HARMONY GH180, power cells (see Figure 2) are linked together in series to build the medium voltage power output (see Figure 1) of the drive system. This modular configuration gives the SINAMICS PERFECT HARMONY GH180 many advantages when it comes to maintenance, power quality and reliability. It also provides the basis for one of its most important advantages – increased availability through the advanced cell bypass option.

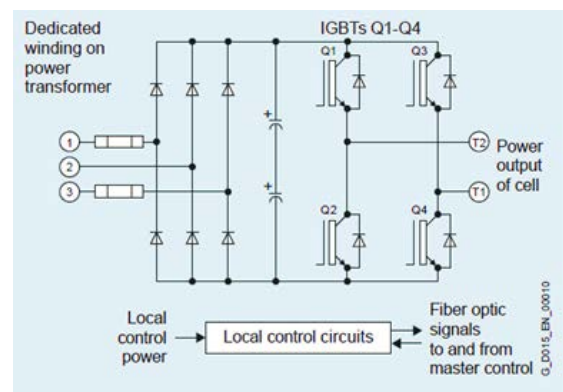

Figure 2: Schematic of a typical power cell

Advanced cell bypass

The SINAMICS PERFECT HARMONY GH180 is designed to withstand failures that would overwhelm conventional drives because redundancy options are added into the system. The patented, cell-based configuration maximizes uptime and simplifies modifications.

Through a redundant bypass control that is completely separated from each power cell, SINAMICS PERFECT HARMONY GH180 ensures automatic bypass of a failed power cell in 250 ms. The mechanical cell bypass option is implemented by providing a contactor at the output of each cell. One of the many benefits of mechanical cell bypass includes the ability to be tested during customer factory acceptance test.

Since the cells in each phase are in series, bypassing a cell has no effect on the current capability of the drive, but the voltage capability will be reduced. Usually the required motor voltage is roughly proportional to frequency (speed). With a power cell or cells in bypass, the maximum speed the motor can operate at may be reduced approximately in line with the reduced voltage. The reduction in speed is somewhat load dependent.

It is important to maximize the motor voltage available after one or more cells have been bypassed. The following figures illustrate the voltage available from a SINAMICS PERFECT HARMONY GH180 drive, where the cells, represented by circles, are shown as simple voltage sources. Figure 3 shows a 15-cell drive in which no cells are bypassed. With 100 % of the cells in use, 100 % of the original voltage is available. The voltage commands to the three phase groups of cells will have phase A displaced from phase B by 120°, and from phase C by 120°.

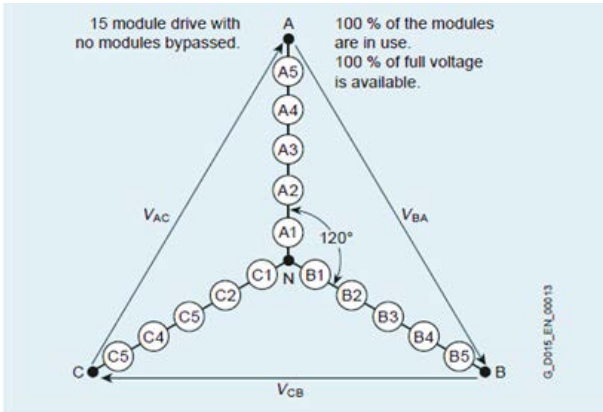

Figure 3: Simplified diagram of a 15 cell drive

When two cells are bypassed in phase A, the output voltage will tend to become unbalanced, as illustrated in Figure 4 and not suitable for operating a motor.

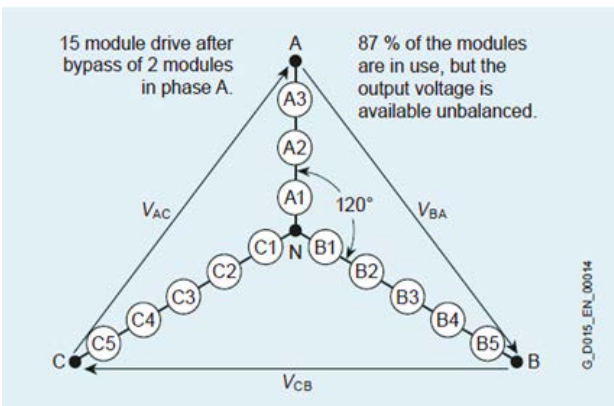

Figure 4: Drive output with 2 cells bypassed in phase A

One possible remedy is to bypass an equal number of cells in all three phases, even though some may not have faulted. Figure 5 illustrates this approach.

Obviously, this method prevents unbalance but sacrifices possible voltage capability. In this figure, 87 % of the cells are functional, but only 60 % are in use, and only 60 % of full voltage is available.

A better approach is illustrated in figure 6. This method takes advantage of the fact that the star-point of the cells is floating and is not connected to the ground. Therefore, the star-point can be shifted away from the motor neutral, and the phase angles of the cell voltages can be adjusted, so that a balanced set of motor voltages is obtained even though the cell group voltages are not balanced. Siemens calls this approach Neutral Shift (Siemens patented technology).

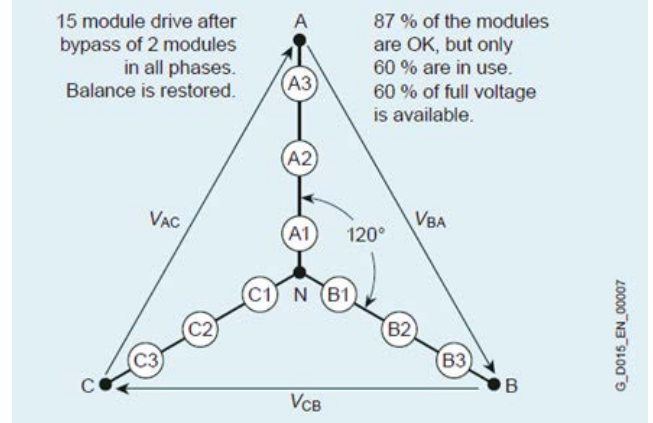

Figure 5: Drive output rebalanced by bypassing functional cells

In figure 6, the full remaining 87 % of functional cells are in use, and 80 % of the original voltage is available. The phase angles of the cell voltages have been adjusted so that phase A is displaced from phase B and from phase C by 132.5°, instead of the normal 120°.

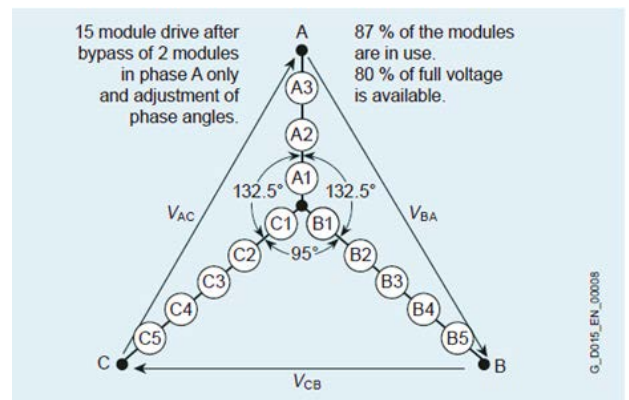

Figure 6: Drive output rebalanced by adjusting phase angles (Neutral Shift)

The figure 7 below demonstrates the available output voltage after one cell is bypassed based on number of cells in configuration and bypass method used. For example, SINAMICS PERFECT HARMONY GH180 (3 cells per phase) with neutral point shift is capable to provide 83 % of output voltage compared to below 70 % for the drive with the same number of cell but without neutral point shift capability.

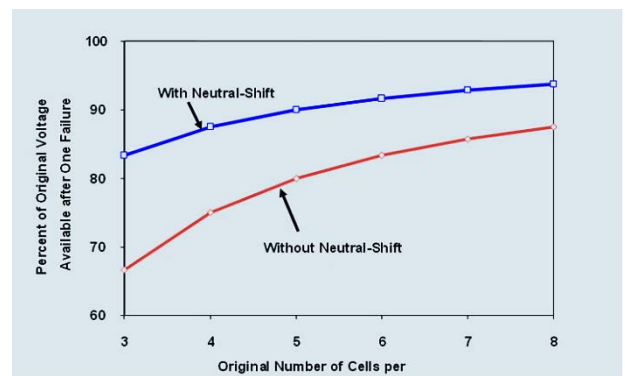

Figure 7: Available output voltages after bypass

PERFECT HARMONY GH180 cell bypass evolution

The SINAMICS PERFECT HARMONY GH180 has revolutionized medium voltage power conversion. Perfect Harmony multilevel topology was invented by Robicon (now Siemens) in 1994. Siemens continues to be the technology leader for multilevel topology inverters and has over 50 unique patents and 100 international patents filed around Perfect Harmony topology. In 2017 Siemens began releasing its 5th generation of SINAMICS PERFECT HARMONY GH180. The complete 5th generation air-cooled range was released in 2021.

The SINAMICS PERFECT HARMONY GH180 drive continues to set industry standards for reliability and innovation. Siemens improves each generation in three key areas: increased reliability and availability, increased efficiency, and a smaller drive footprint. The innovation includes further improving cell bypass technology: evolving from an electronic thyristor based bypass (SCR) integrated to each cell to a mechanical bypass totally independent of the cell.

Cell bypass evolution

In the original concept as implemented 25 years ago, each cell contained a single phase rectifier bridge with a thyristor. The AC inputs of this rectifier bridge were connected to the cell output terminals. In the event of the failure bypass SCR is shorted effectively disconnecting the cell from the input power. Although this approach was effective under certain failure conditions, it had several drawbacks:

- Since cell and bypass share fiber optic communication, if it is lost, then the bypass can not be engaged because the control can not activate cell bypass due to the failed communications. Therefore, this bypass system is less effective and less reliable.
- If there is any component failure in the cell such as IGBT, gate drive, cell control board power supply that may lead to bypass control malfunction resulting in the loss of the bypass functionality.
- To protect cell from exposure to fault current bypass circuitry had built-in fuse, that would automatically blow when cell bypass is engaged. If it was a nuisance trip customer could not automatically reset it which required a new cell for replacement.

In 2000, to overcome these difficulties, bypass was changed to an external mechanical contactor supplied from a completely independent power source and controlled by a separate control means. This contactor does not have to interrupt current, so it doesn't need arc control measures. The contactor is a single pole double throw arrangement so that it can disconnect the cell from the output string and apply a shorted contact in place of the cell. With this bypass, the cells do not have to function at all for bypass to work.

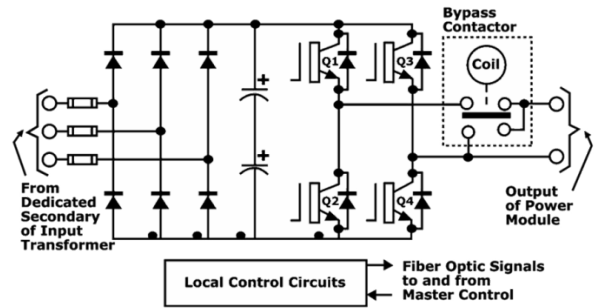

Advantages of the mechanical cell bypass

- The SINAMICS PERFECT HARMONY GH180 bypass is based on traction DC contactor – proven and trusted technology!
- It does not matter which of the components has failed within the cell. In fact, even a failure in the fiber optic link that communicates to the cell can be detected and bypassed. This approach protects against the failure of any component in the power circuits or in the communications circuits, rather than protecting the drive against power semiconductor failure only.
- Mechanical bypass has separate communication with the drive control and independent regulated power supply to ensure maximum availability.
- In the instance of a nuisance trip customer can automatically reset bypass and continue the operation.
- During the fault, drive control performs a quick check to verify if the motor output voltage can be supported by the functional cells before a cell is bypassed. This voltage can be near the drive rated output voltage for a few seconds before dropping over time. If a cell is bypassed too fast, the remaining cells may not be able to support this voltage and leading to cells malfunction. SINAMICS PERFECT HARMONY GH180 has built-in control function to perform all necessary checks to ensure safe and reliable operation.
- When a cell is bypassed, it allows for process ride through with an interruption of only 250 ms or less.

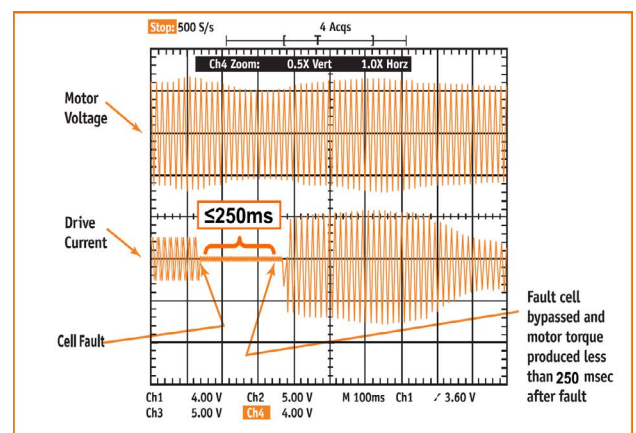

SINAMICS PERFECT HARMONY GH180 solutions

Drive heat load management

During operation, every drive generates heat that needs to be removed from the room to avoid equipment overheating. In many installations, it is very common to use air-conditioning to reduce the heat in the control room. The amount of heat dissipated into the room by the drive depends on the drive size, its running load, cooling method and efficiency. Other equipment located in the same space may also have losses requiring cooling.

The more heat rejected into the room, the higher operational cost and total costs of ownership of the drive are. The drive typical losses are 3.0 to 3.5 % of the motor rating when operating at full load (losses reduce as load reduces). Air-cooled drives usually dissipate heat directly into the room and require additional measures to keep operating within the manufacturer specified range; while water-cooled drives reject most of the losses into the water, less than 5% of losses are rejected into the room.

The difference in cooling requirements for installations where heat rejected directly into the room could be 20 times higher compared to solution where losses are ducted outside the room. For example, 4000 Hp (3000 kW) drive losses in the room are 96 kW while the same drive with ducted air outside or heat exchanger (air-to-air or air-to-water), has only 4.8 kW losses resulting in significant reduction in cooling requirements. In this case heat losses in the room are similar to water-cooled drive performance. In order to reduce the requirement for air-conditioning of a control room, it is worth evaluating various heat management options available for air-cooled drives:

- The air can be ducted directly outside (options M64 or M68)
- Air-to-air heat exchanger (option W41)
- Liquid-to-air heat exchanger

Each approach has its own advantages and limitations and each case should be evaluated based on customer application, site conditions, availability of water, etc. Below are highlights of each option.

Ducting hot air outside is one of the most economical implementations but it does require upfront engineering from a customer. Engineering is required to design proper air flow in the room to avoid creating a vacuum or wind tunnel effect in the room. The air can be drawn either from outside with proper filtration to meet drive installation requirements or in some cases, HVAC is capable of supporting the necessary airflow. It is critical to design the solution properly to prevent unnecessary trips due to lack of air. The regular maintenance of outside filters is required to ensure that no contaminants get into the drive.

Utilization of heat exchangers creates close loop cooling systems. In close loop systems air is drawn through ventilation openings at the bottom or the front of the drive, depending on the product line, then circulated through the transformer and power cell sections and exhausted through the back of the drive enclosure. Warm air is cooled via the heat exchanger and circulated back to the drive. The hot and cooled air is transferred to the heat exchanger by duct work through the control room or power distribution center exterior wall. In case

of liquid-to-air heat exchangers, heat is removed from the hot air and transferred to the customers' water system.

There are two possible ways to implement this configuration the first one is similar to air-to-air heat exchanger set up where heat exchanger itself located outside and the hot air from the drive ducted. The second one is when the VFD blower cage assembly is replaced with the heat exchanger assembly. This solution does not require ducting work done to the building thus reducing additional engineering effort.

The heat exchanger option (either air-to-air or air-to-water) is a self-contained solution that does not require additional engineering on the customer's behalf. Compared to open loop systems, this solution provides higher degree of contamination protection due to the two separate airflow design, which keeps dirt, moisture, and other elements from getting into the equipment.

Heat exchangers might require higher initial investment compared to open loop system or HVAC solution, it typically has the lowest total cost of ownership compared to traditional HVAC and a pay back of 2 to 3 years depending on size of the drive or solution saving operators cost of electricity for the next 17 years of the drive life.



Figure 8 Installation with air-to-air heat exchangers and two drives in the building

Not only this solution reduces overall cost of drive operation, the heat exchanger is also about 5 to 10 % more reliable compared to industrial redundant HVAC systems and about 20 to 30 % more reliable compared to commercial HVAC systems. This reliability improvement is due to fewer components in the heat exchanger compared to HVAC system which consists of compressors, fans, belts, valves, etc. The above figures are based on the data collected by our field support team over past 10 years.

The air-to-air heat exchanger solution has built-in fan redundancy and comes complete with heat exchanger controls. It is rated for ambient temperatures from 32° F to 104° F (0° C to 40° C). When required, they can be equipped with options to meet -40° F (-40° C) including space heaters, louvers and snow hoods for cold environments.

Bidirectional synchronous transfer

There are two primary applications that require synchronous transfer:

- The first one is a drive used as a soft-starter to reduce stress from starting motors directly on line.
- The second one is used for process/flow control: starting up multiple motors and synchronizing them to the line according to process specifications.

The key difference between these applications is sizing of the drive. When variable frequency drive (VFD) is used to start the motor in an unloaded condition, the VFD does not have to match the full rating of the motor. For example, a 20,000HP motor may be started by a 5000HP VFD if the drive output can provide sufficient output current and develop enough motor torque to accelerate the motor up to full speed. In this instance, the VFD is at full power only for a very short period of time. The drive transfers a motor across the line after the motor is at full speed. In all cases the motor is started in either unloaded or partially loaded condition.

The drive is often used in this application when incoming line is soft and cannot support the inrush current of the motor during starting. Sometimes, the incoming line is even too weak to support a reduced-voltage start even though inrush current is less it is still about 250% to 300% of the motor full load current rating. Starting motors with VFDs have the following benefits:

- Multiple starts per day
- Draws minimal inrush currents while starting, minimizing voltage drop and system electrical stress
- Reduces mechanical shock (starting torque is controlled at nominal levels)

For such applications the SINAMICS PERFECT HARMONY GH180 has a function for single motor synchronous transfer option (L29) that does not require any PLC, it is done by the drive's control and in most cases without need for an output reactor.

For the second option, the drive is sized to run the motor full time. In a pumping station, the demand can change significantly within a day for the water and wastewater industry and seasonally for oil pipelines. One variable frequency drive can be used in combination with multiple motors to adjust the flow to meet the demand. In this case, the last pump is always run by VFD for flow and pressure control.

Siemens can design your sync transfer system to suit your application. With standard, pre-configured systems that utilize our best-in-class VFD and motor control products, Siemens can provide a full spectrum of standard and flexible options.

Once the sync transfer system has been completely assembled, Siemens performs full power testing to ensure seamless integration and operation. Components are assembled and tested. The Sync Transfer Control System (STC) supports transfer of two to eight motors directly to or from a line source of power. The system is designed to handle induction motors or synchronous motors and connection of motors to a source the same as the drive or to an alternate source.



Figure 9: Switchgear and reactor lineup for 3 motor synchronous transfer application (for drive manufactured in the USA only)

Optimized synchronous transfer

The traditional synchronous transfer option uses output reactor for a bump-less closed transfer (figure 10). Connecting voltage source VFDs to a motor in parallel to the line (closed transfer) can result in excessive currents. The solution used to prevent such excessive currents has always been to add a reactor between the VFD output and the motor.

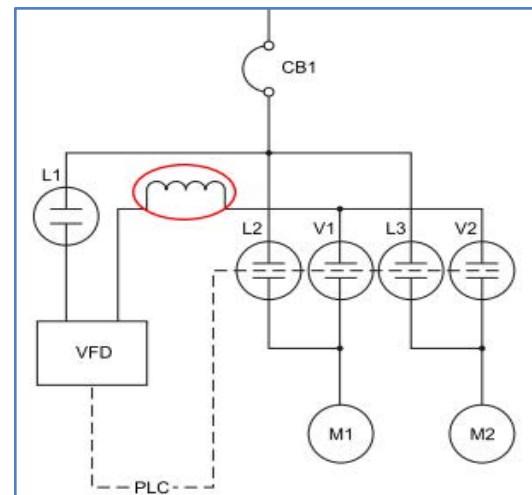

Figure 10: Typical multi-motor synchronous transfer application with reactor

The advantage of this implementation is the ability to operate for periods of time in parallel with the line. This makes the transfer from the line to the VFD as smooth as possible. The limitation of this solution is higher initial capital cost, increase of the losses within the drive system and reduced output voltage capability of the drive system. While the losses and voltage drop are negligible with regards to motor operation, the reactor losses require additional cooling. The cooling of these losses is either can be done by placing the reactor outside or increasing the HVAC capability of the cooling system. Regardless, the capital cost of including a reactor is considerable.

Due to increases in drive control processing power synchronous transfer can be optimized to eliminate the use of an output reactor. This optimized synchronous transfer can be applied to most motor drive applications.

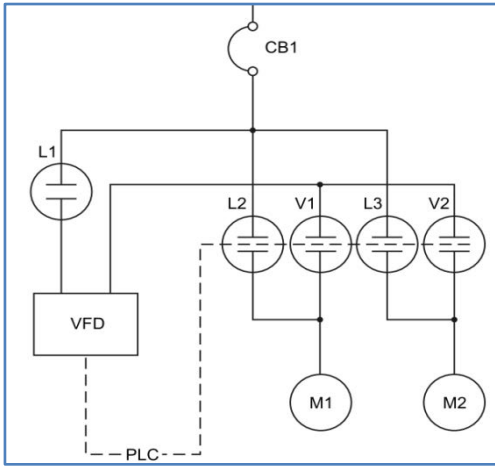

Figure 11: Optimized multi-motor synchronous transfer

The benefit of this approach is the ability to remove the reactor between the VFD and the motor, and the associated motor line contactor feedback to the SINAMICS PERFECT HARMONY GH180 VFD. Synchronous transfer of the motor to the line remains as a closed bump-less transfer.

The optimized synchronous transfer does differ during "down" transfer. When the motor is transferred from the line back to VFD while it is still closed transfer, it will result in a step torque change to the motor but it has minimal impact on process. The magnitude of this step change is limited to the allowable torque.

Optimized synchronous transfer of motor to line (up transfer)

Optimized synchronous transfer operates in the same manner as the traditional GH180 transfer operation with regards to "up" transfer so the same operational logic and application methods apply. The graph below shows the motor operation during an "up" transfer:

- The magenta waveform is the voltage magnitude as seen by the motor.
- The blue waveform is the output voltage of the VFD.
- The green waveform is motor current
- The red waveform is the control voltage for the VFD's output contactor

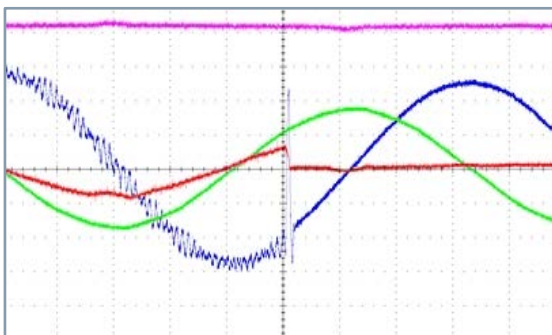

Figure 12: Optimized synchronous up transfer

As shown in the graph, there is no observable change in motor voltage or current. This means that there is no meaningful change in motor torque during an "up" transfer, and it is synchronized with the line phase and frequency.

Optimized synchronous transfer of motor to the VFD (down transfer)

Optimized synchronous transfer of the motor to the VFD operates almost identically to the traditional SINAMICS PERFECT HARMONY GH180 "down" transfer method. All existing logic which was used previously can be applied to the optimized synchronous transfer.

The VFD output is connected in parallel with the motor. When the VFD senses the voltage on the output, it synchronizes with this voltage. Once synchronized, the VFD signals to open the motor's line contactor. Once the motor's line contactor opens, the VFD starts operation without waiting for the line contactor open signal.

The chart below is a capture of an optimized synchronous "down" transfer:

- The magenta waveform is the motor voltage magnitude
- The red waveform is the VFD output current
- The blue waveform is VFD/Motor voltage

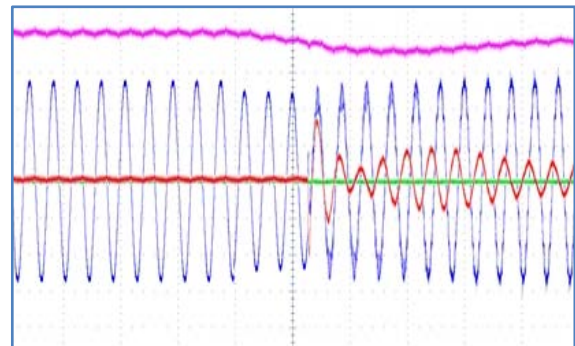

Figure 13: Optimized synchronous down transfer

The graph shows negligible effect of the zero torque state. During the time between the opening of the motor's line contactor and the VFD starts operating the torque of the motor will be zero. During "down" transfer the SINAMICS PERFECT HARMONY GH180 uses sophisticated sensing to determine the state of the line contactor. This sensing will adapt automatically to the application. This approach prevents timing issues and greatly reduces the process impact caused by the brief zero torque state.

Additional considerations

There are a few rare cases that require additional analysis before using optimized synchronous transfer solution:

- excessive system short circuit current ratings:
 - for smaller drives (40 to 70 A), the short circuit current at the drive's input should not exceed 35 kA,
 - the short circuit current should not exceed 200 times of the drive's rated output current.
 - In these cases, a 1 % reactor is required.
- excessive torque variations during steady state operation, and
- extremely low motor/load inertia, for example electrical submersible pump application.

If your site or load falls into this category, the optimized synchronous transfer may be modified to fit your application. If this is not possible, the traditional synchronous transfer remains available to ensure all applications have the opportunity to use synchronous transfer for bypass operation.

Summary

The optimized synchronous transfer system allows for bypass operation without the need for an output reactor.

- Optimized and traditional synchronous "up" transfers are equivalent with no interruption of motor torque.
- Optimized synchronous transfer has a brief torque interruption during "down" transfer operation - interruption is kept brief by an adaptive algorithm which senses contactor status via motor behavior

When selecting the synchronous transfer option, Siemens recommends that customers install motor protection relay (MPR). Once the motor is transferred directly on line, it is no longer protected by the VFD. In case of the multi motor synchronous transfer option (N18), Siemens integrates an MPR with associated CTs and PTs into the switchgear line-up. If switchgear is supplied by the customer (L20), it is customer responsibility to install the MPR.

For both options, Siemens provides a synchronous transfer controller with predefined and tested logic up to 8 motors and built-in HMI for display. The controller can be installed as a part of the line-up or separate in a control room depending on customer requirements. Siemens solution is the most flexible and provides support for the customers' selection of switchgear and motor protection relay to ensure the best fit for their site and application.



Electrical Submersible Pump Application

Approximately 90% of all oil wells require some form of artificial lift to improve oil flow. Electrical Submersible Pump (ESP) is one of several methods used in the industry. Once the oil reservoir stops producing oil under free flow, electrical submersible pumps are used to pump the oil to the surface.

Historically, low voltage drives have dominated in ESP applications, but recently more and more end-users are considering and using medium voltage drives. An ESP is a centrifugal pump that is driven by a medium voltage electric motor that ranges from 1000 V to 6600 V.

More often than not, ESPs are installed in remote locations. The power is more susceptible to disruptions from outages, poor voltage regulation, and transient voltage conditions. The design, operational and site constraints make these motors sensitive to the following conditions:

- Input line overvoltage and transient spikes
- High inrush torques
- High dv/dt
- Torque pulsations

One of the most common ESP motor and cable failures is short-circuited motors and cables. The reason for short circuit events is insulation break down. The LV drive solution, if not properly selected and engineered, may produce high output voltage spikes that lead to insulation break down of both cable and motor. The ESP failures have a very high cost. The total cost to an end-user of one ESP failure is about \$154K. Below is the breakdown of the average cost associated with the onshore ESP operation:

- Average loss of revenue $\$60 \times 200 \times 7 = \$84K$ based on:
 - Price per barrel - \$60 (can be as high as \$100 depends on market conditions); average oil production per well: 200 bopd (barrels of oil per day) and average workover & waiting time: 7 days
 - Average intervention cost is \$20K (maybe higher depending on a cost and availability of a rig) and average equipment cost of \$50K

SINAMICS PERFECT HARMONY GH180 provides the best solution for this application. Siemens has over 1000 units installed globally in this application alone. It offers inherent almost sinusoidal output voltage waveform, low harmonics and negligible torque pulsations:

- Less than 1% VFD induced torque ripple for any given frequency: no motor heating and no bearing wear
- 13 level output waveform line to line and small output voltage steps (1.3kV): no voltage spikes at the motor
- No need for filters up to 7500ft (2.3km)
- Waveforms remain high quality at lower speeds

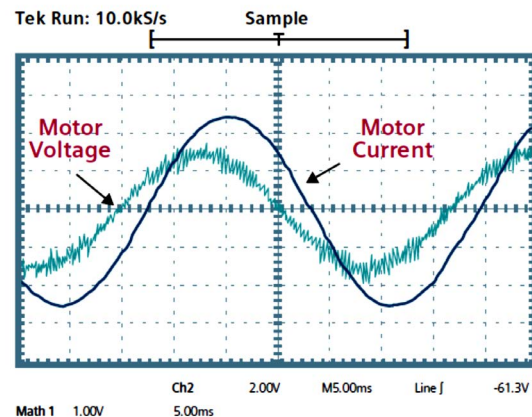

Figure 14: Output waveform

SINAMICS PERFECT HARMONY GH180 input configuration waveform:

- Meets the most stringent requirements for voltage and current harmonic distortion, even if the source capacity is no larger than the drive rating
- Less than 3 % total voltage distortion
- Less than 3 % total current distortion

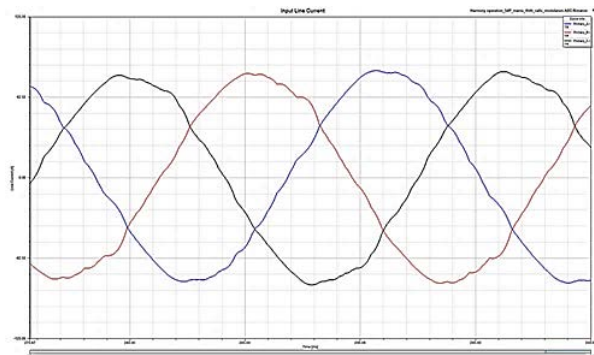

Figure 15: GH180 input waveform (9-cell, 54-pulse)

In addition, the SINAMICS PERFECT HARMONY GH180 provides the following benefits compared to a LV solution:

- No step-up transformer needed, the drive has direct feedback from the motor – output voltage ranging from 1.8 kV up to 6.6 kV.
- No restriction on starting torque – 100 % of torque is available at 1.6 Hz speed – this would significantly reduce motor stress compared to kick start of LV drive.
- When pump gets stuck due to sediment collection, the drive can produce 150 % of rated torque required to free the motor or if additional effort is needed drive can engage "rocking" function to free the pump.
- In locations that have frequent lightning storms, the drive offers standard distribution arrestors to provide protection to drive, cables and motor.
- Flexibility with simplified and optimized input voltages from 480 V up to 13.8 kV (higher input voltages on request).

Torque during ride-through

ESP applications typically operate in regions where momentary power interruptions occur. These momentary power interruptions cause a loss of input power feeding the drive. The drive will respond by entering a mode called ride-through. The VFD performance during the voltage sag tolerance and ride-through of momentary power loss depend on the amount of capacitance available in the DC link. The tolerance level varies from manufacturer to manufacturer and ranges from 90% to 75% of nominal input voltage.

At full speed, the SINAMICS PERFECT HARMONY GH180 provides regular operation for dips down to 90% of nominal voltage. After that the drive output power is rolled-back linearly from 100% power at 90% of input voltage down to 50% power at 66% of nominal input voltage. Output power is reduced by limiting the available motor torque. The VFD can operate continuously in this mode. When the input voltage falls below 66%, then the power is quickly reduced to a slightly negative value (regenerative limit) (figure16). This limit forces the drive to absorb power from the motor and maintain the DC bus voltages in case the input voltage recovers during MV ride-through.

This typical ride-through action is the most effective drive response for most applications. However, some applications with very low system inertia and high loads are willing to sacrifice ride-through duration to maintain enough torque to prevent stopping the process.

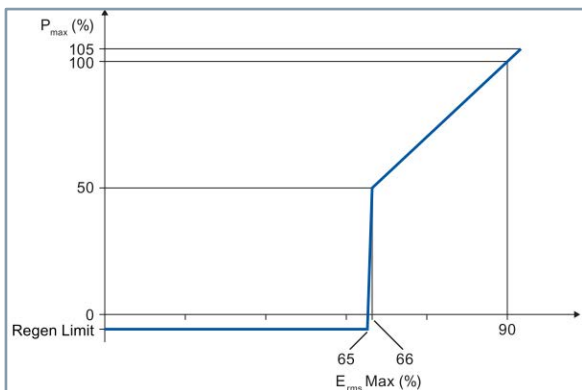

Figure 16: GH180 torque during input voltage sag and ride-through

ESPs have low system inertia and a high load. Losing torque, even for a short time, will cause the flow to stop and reverse direction. At this point, one must wait for the column of fluid to drain back through the pump and sediment to settle before restarting the pump. Once started, one must refill the column of fluid before production is restored. This all wastes energy and time resulting in less revenue.

Given the cost of time and energy to restore production in ESP applications, it is more important to maintain the process through application of torque during a short power interruption than the ability to instantly reapply torque after an extended power interruption.

Solution

For applications such as ESPs, SINAMICS PERFECT HARMONY GH180 drives implement a scheme which allows to maintain some torque for a short time during ride-through. The power for this torque is the power stored within the DC filter banks of the power cells.

During ride-through, drive will provide torque to hold a preset speed for up to 100 milliseconds (5 cycles). After this period, the drive returns to the original ride-through algorithm where a slight regenerative torque is applied, and motor flux is maintained until DC power is exhausted or line voltage returns.

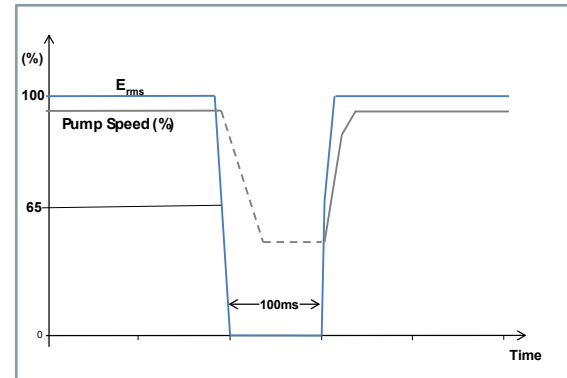

Figure 17: Typical pump speed response during extended torque ride-through

Summary

Extended torque ride through uses the energy stored in the DC filter capacitors to extend the torque available from the drive when a brief power interruption occurs. The benefits are:

- Enough torque is supplied to maintain minimum flow to prevent pump cavitation
- No reverse flow following momentary power outages
- No waiting for the column of fluid to drain sediment to settle before restarting
- No wasted energy refilling the column of fluid before production begins

SINAMICS PERFECT HARMONY GH180 54-pulse solution

IEEE 519-2014, "Recommended Practices and Requirements for Harmonic Control in Electric Power Systems", is the standard for input harmonics in North America. It recommends limits for individual harmonics and total distortion. The goal is to limit harmonics at Point on a Public Power Supply System Coupling (Point of Common Coupling), defined as the utility/customer connection point, focusing on current distortion limits for the user and on voltage distortion limits for the supplying utility.

The primary reason for harmonic distortion is non-linear loads including but not limited to VFD. Such loads draw non-sinusoidal currents from the power supply which, in turn, causes distortion in the voltage waveform at the point-of-common coupling. This distortion may impact other customers by reducing system efficiency or adding additional stress for equipment connected to the same power supply.

Siemens traditional implementation has a proven record that the performance of an 18-pulse drive is within the limits of IEEE 519. Typically, a VFD with 9 cell configuration lowers harmonic distortion at its input by phase shifting its transformer windings. The windings (one per each phase) are shifted 20° apart to achieve 18 pulse. As shown in Figure 18, with an 18-pulse VFD input, the current THD is 3.5% — well below the 5% limit set forth by IEEE 519. Telephone Interference Factor (TIF) is 114.

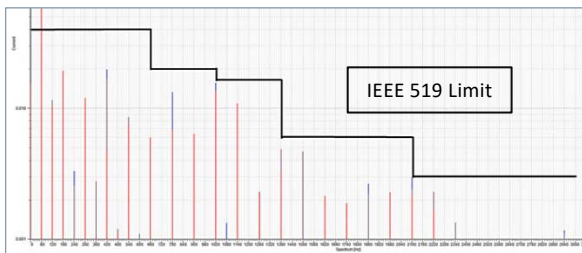

Figure 18: Input current harmonics with an 18-pulse VFD

As Siemens continue to improve performance of the SINAMICS PERFECT HARMONY GH180, we further reduce input harmonics with the same number of windings. Siemens new standard solution is 54-pulse 9-cell configuration. Each cell in SINAMICS PERFECT HARMONY GH180 has 6 pulse rectifier that in the past was shifted in the group of three (see figure 19). In the new configuration each individual cell winding is shifted 6.6° apart (see figure 19) to achieve 54 pulse rectification without additional hardware and does not affect the drive footprint. The new design offers more than 15 % improvement in current distortion and more than 30 % in TIF compared to 18-pulse configuration.

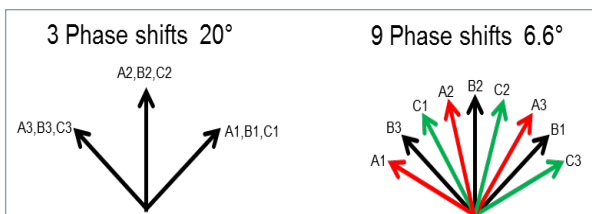

Figure 19: Example of transformer winding phase shifting

Example of harmonic spectrum of 54 pulse is represented in Figure 20, the data show THD of the current is 2.9 % and the TIF is 77.

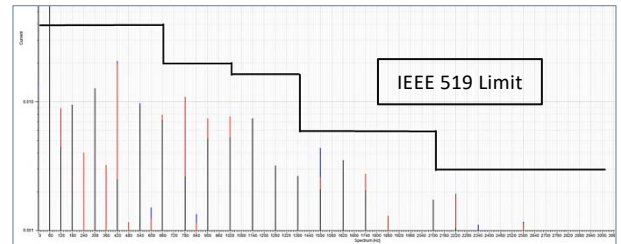

Figure 20: Input current harmonics with an 54-pulse VFD

IEEE 519-2014 defines levels for Total Current Demand Distortion (TDD(I)). Most manufacturers measure and show cumulative amount of harmonic distortion or Total Harmonic Current Distortion (THD(I)). IEEE requires distortion measured at 100% load, at this point THD(I) equals to TDD(I). The improvement in current waveforms is shown in Figure 21.

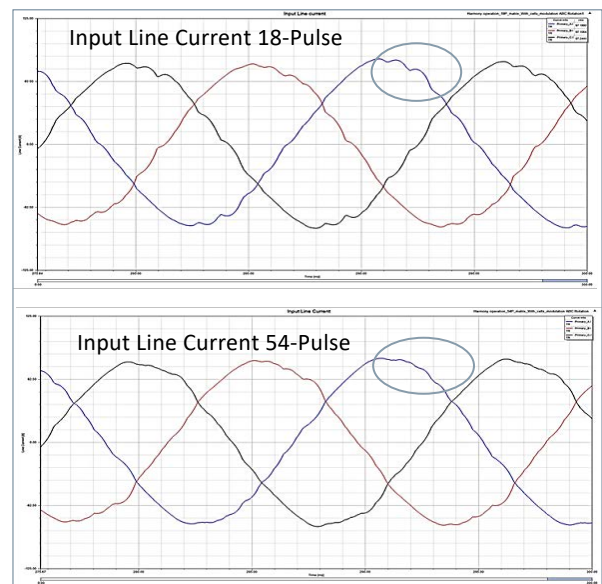

Figure 21: Input line current waveforms

An additional benefit of 54-pulse solution compared to 18- and 24-pulse configurations is cancellation of higher order of harmonics. Typical harmonic cancelation based on number of pulses:

18-pulse: 5, 7, 11, and 13

24-pulse: 5, 7, 11, 13, 17 and 19

54-pulse: 5, 7, 11, 13, 17, 19, 23, 25, 29, 31..., 47 and 49

The harmonics measurements mentioned in this discussion are based on ideal steady state operation of the drive and assuming the power supply network is symmetrical and free from harmonics. In real world conditions, the supply networks or connected equipment never follow the ideal environment and therefore, the actual measured harmonics would not be exactly as calculated or simulated. Our theoretical analysis and simulations for 54 pulse design were completed and verified by actual field testing and data.

SINAMICS PERFECT HARMONY GH180 water-cooled drive



SINAMICS PERFECT HARMONY GH180 water-cooled drives are designed to provide output power from 4,000 HP to 33,000 HP (3 to 24.6 MW) in a single channel and output voltages from 3.3 kV to 11.0 kV. The GH180 water-cooled drives are approved for manufacturing only from the USA (New Kensington) location.

To support critical high power applications, Siemens redesigned its SINAMICS PERFECT HARMONY GH180 water-cooled drive to be 20 % more compact and more powerful with cell current rating of 1375 A. The streamlined design offers the same proven reliability and performance as before, but within a smaller footprint and additional configuration flexibility that makes it even more versatile.

The result is a simplified system that's composed solely of a transformer cabinet, cell cabinet and cooling cabinet. There's less programming needed, and fewer components with fewer connections means maintenance time is minimized, too.

Reliability is improved by reducing the number of threaded fittings on the water-cooled VFDs and replacing long hoses with copper pipe. Every aspect of the drive is optimized to fit small spaces while remaining compatible with — and delivering superior reliability to — virtually every application.

Built-in safety

The inherent benefit of the distributed power structure of the PERFECT HARMONY multi cell topology results in significantly reduced fault energy stored in the inverter section (equivalent of the low voltage drive) as compared to other available technologies. To provide additional protection, every SINAMICS PERFECT HARMONY GH180 water-cooled drive includes the Arc Detection System as a standard feature in power cells since its design in 2006.

The inverter section consists of cells equipped with arc detection sensors and the control to communicate with the drive system. This communication is supported by the Advanced Protocol software. In the rare event of cell arcing, the Advanced Protocol will initiate the shutdown of the inverter within 20ms and the drive control will issue a trip signal to an external breaker.

When combined with suitable fast acting circuit breakers on the input and output circuits, the SINAMICS PERFECT HARMONY GH180 VFD can be effectively disconnected from the input line and the motor in a short duration. Recommended total opening time of the circuit breaker must not exceed 80. The drive monitors the total opening time.

The purpose of Arc-Fault Detection is to minimize the impact of the arc by reducing the time needed to trip the circuit breaker and interrupt the fault.

Advanced cooling cabinet option

Customers that require high level of monitoring and redundancy will benefit from advanced cooling cabinet option (W32). This option offers a larger cabinet to provide easier access to components and for easier maintenance. To support maintenance, the cabinet has a built-in hoist and rail system for changing the pumps. The pumps are equipped with two low-voltage variable speed drives for better motor control of the pumps which, in turn, increases the reliability, efficiency and life of the pumps. Automatic switchover between pumps will occur in the event of one of the pumps failure or loss of flow. The customer has the freedom to program pump cycling based on their system requirements. The advanced cabinet supports both air-to-water and liquid-to-liquid heat exchangers.

There are several signals available for remote monitoring through customer SCADA or plant HMI to provide timely feedback on performance of the entire cooling system including external heat exchanger. Increased monitoring allows for advanced indication of coolant system issues before the drive control issues an alarm or trip. These signals include:

- water level
- flow
- conductivity
- pressure and temperature
- In addition to pump status, pump VFD status is also available for remote monitoring
- individual fan monitoring/status of the external liquid-to-air heat exchanger.

Options

Availability by manufacturing location

- X Option is available
- E Engineering is required; not configurable in the tools
- Option is not available
- AC Air-cooled only option
- WC Water-cooled only option

Options	Location			
	China	Germany	USA	Brazil
A				
A30 Touchscreen with standard cable (HMI)	E	–	E	E
A34 Input and output thermal temperature monitoring	X	E	AC	E
A59 PEXTRON RTD monitor	–	–	–	X
A60 TEC system 8 channel RTD monitor	X	–	–	X
A76 System arc detection	X	E	AC	E
A80 TEC System 12 channel RTD monitor	X	X	AC	X
A82 SEL 710 motor protection relay	E	E	AC	E
A83 Multilin 869 motor protection relay	E	X	X	X
A95 Environmental condition monitoring	X	E	AC	E
B				
B09 ESP application	E	E	E	E
B43 Production schedule: one issue	X	X	X	X
B44 Production schedule: updated at 2-week intervals	E	X	X	X
B45 Production schedule: updated once per month	E	X	X	X
B49 Manufacturer data book	–	X	–	X
C				
C68 SINAMICS CONNECT 500	X	X	X	X
D				
D00 Documentation in German	X	X	X	X
D02 Circuit diagrams, terminal diagrams and dimension drawings in DXF format	X	X	X	X
D15 One set of printed documentation	X	X	X	X
D54 Documentation in Czech	E	E	E	E
D55 Documentation in Polish	E	E	E	E
D56 Documentation in Russian	X	X	X	X
D57 Documentation in Japanese	E	E	E	E
D62 Documentation in Danish	E	E	E	E
D71 Documentation in Romanian	E	E	E	E
D72 Documentation in Italian	E	E	E	E
D73 Documentation in Finnish	E	E	E	E
D74 Documentation in Dutch	E	E	E	E
D75 Documentation in Turkish	X	X	E	E
D76 Documentation in English	X	X	X	X
D77 Documentation in French	X	X	E	E
D78 Documentation in Spanish	X	X	E	X
D79 Documentation in Portuguese	X	X	X	X
D80 Documentation in Bulgarian	E	E	E	E
D81 Documentation in Norwegian	E	E	E	E
D82 Documentation in Hungarian	E	E	E	E
D83 Documentation in Swedish	E	E	E	E
D84 Documentation in Chinese	X	X	X	E
D85 Documentation in Slovenian	E	E	E	E
D86 Documentation in Greek	E	E	E	E
D87 Documentation in Slovakian	E	E	E	E

Options	Location			
	China	Germany	USA	Brazil
D88 Documentation in Estonian	E	E	E	E
D89 Documentation in Latvian	E	E	E	E
D90 Documentation in Lithuanian	E	E	E	E
E				
E00 Motor static excited furnished by customer	E	–	E	E
E01 Motor static exciter furnished by Siemens	–	–	WC	–
E03 Control of permanently excited motor	E	E	E	E
E04 Additional customer analog, digital inputs and outputs (I/O) modules	X	X	X	X
E06 Additional customer analog, digital inputs and outputs (I/O) modules	–	–	–	E
F				
F03 Visual acceptance of the drive	E	X	–	X
F73 Functional acceptance of the drive with inductive load	X	X	–	X
F77 Acceptance test of the insulation of the drive	E	X	–	X
F79 Interface check with customer equipment (5 hours, on request)	E	X	–	E
F97 Customer-specific acceptance	E	X	–	X
F02 Class 1 witness test	–	–	X	E
F94 Class 2 witness test	–	–	X	E
F95 Class 3 witness test	–	–	X	E
G				
G22 Modbus RTU interface, network	X	X	X	X
G23 DeviceNet profile 12 interface, network 1	X	X	X	X
G28 Modbus Ethernet interface, network 1	X	X	X	X
G32 Modbus RTU interface, network 2	X	X	X	X
G34 PROFINET, network 1	X	X	AC	X
G37 EtherNet/IP interface, network 1	X	X	AC	X
G38 Modbus Ethernet interface, network 2	X	X	X	X
G39 EtherNet/IP interface, network 2	X	X	AC	X
G41 Ethernet network switch without fiber optic port	E	–	E	X
G42 Ethernet network switch with fiber optic port	X	–	X	X
G43 DeviceNet profile 12 interface, network 2	X	X	X	X
G47 Ethernet port connector mounted on the door	X	X	X	X
G89 Digital relay contactor control of external auxiliaries	–	–	WC	–
G91 PROFIBUS DP interface, network 1	X	X	X	X
G93 PROFIBUS DP interface, network 2	X	X	X	X
H				
H03 1000 mm option cabinet	X	–	–	–
K				
K20 Signal lamp on the cabinet door	E	X	AC	X
K21 Display instruments for voltage, current and speed	E	X	AC	X
K29 Pushbutton / potentiometer kit	E	X	AC	X
K31 Off-Local-Remote selector switch	X	X	X	X
K32 Off-Hand-Auto selector	X	X	AC	X
K33 Keyed Off-Local-Remote selector	X	X	X	X
K34 Keyed Off-Hand-Auto selector	X	X	AC	X
K50 Closed loop vector control with provision for speed encoder	E	E	E	X
K68 Control voltage 220V AC by customer.	X	X	X	X
K69 Control voltage by Siemens	X	X	X	X
K73 I/O signal voltage 24 V DC	X	X	X	X
K79 Control voltage 120 V AC by customer	–	X	X	X
K86 Safe Torque Off (STO)	X	X	AC	X

Options	Location			
	China	Germany	USA	Brazil
L				
L03 EMC filter	X	X	X	X
L09 Output reactor	E	E	E	E
L20 Bidirectional synchronized transfer of multiple motors, switchgear provided by customer	E	E	E	E
L29 Bidirectional synchronized transfer	X	X	X	E
L33 Regenerative braking	–	–	WC	–
L36 Input snubber	E	E	X ¹⁾	X
L50 Cabinet lighting and service socket outlet	E	X	E	X
L53 UPS for power supply of the control	X	X	X	X
L55 Anti-condensation heating for cabinet	X	X	X	X
L81 2 x 2 thermistor protection relays	E	X	–	E
L82 3 x 2 thermistor protection relays	E	X	–	E
L85 Redundant control power	–	–	WC	E
L89 Pt100 evaluation unit with 6 inputs for ex-proof motors, 6 analog outputs	E	X	–	E
L91 2 Pt100 evaluation units with 3 inputs each	E	X	–	E
L93 Pt100 evaluation unit with 6 inputs and 2 analog outputs	E	X	–	E
M				
M08 Superior – mechanical door interlocks	E	E	X	X
M09 Kirk – mechanical door interlocks	E	E	X	X
M10 Castell – mechanical door interlocks	E	X	E	E
M12 Electrical door interlocks	E	E	–	E
M29 Painted steel gland plates	X	X	AC	X
M35 Aluminum gland plates	X	X	AC	X
M36 Brass gland plates	X	X	X	X
M37 Stainless steel gland plates	X	X	X	X
M38 Fortress – mechanical door interlocks	E	E	–	E
M42 IP42 degree of protection	X	X	AC	X
M46 INDAC – mechanical door interlocks	–	–	–	X
M53 24" option cabinet	E	X	X	X
M57 Arc resistant design 40 A to 430 A	X	–	AC	–
M61 Redundant blower	X	X	AC	X
M64/M68 Drive prepared for duct flange connection in front/rear	X	X	AC	X
M88 Premium corrosion protection	–	–	WC	–
M92 Munsell N6.5	–	–	–	X
M97 RAL 7035	X	X	E	X
M98 ANSI 61	E	E	AC	X
N				
N02 Interface with customer circuit breaker – DC rated dry contacts	–	–	WC	–
N03 Interface with customer circuit breaker – AC rated dry contacts	–	–	WC	–
N10 Prepared for input contactor	E AC	E AC	E AC	E AC
N13 Prepared for input circuit breaker	E AC	E AC	E AC	E AC
N17 Bidirectional synchronized transfer of one motor, switchgear provided by Siemens	–	–	E AC	E AC
N18 Bidirectional synchronized transfer of multiple motors, switchgear provided by Siemens	–	–	E AC	E AC
N26 Synchronized pre-charge and pre-magnetization of transformer	E AC	E AC	WC E AC	E AC
N30 Controlled 3-phase outgoing auxiliary feeder max. 4.8 kW	E	–	AC	X
N31 Controlled 3-phase outgoing auxiliary feeder max. 8 kW	E	–	AC	X
N32 Controlled 3-phase outgoing auxiliary feeder max. 12.7 kW	E	–	AC	X
N33 Controlled 3-phase outgoing auxiliary feeder max. 17.5 kW	E	–	AC	X
N35 Controlled outgoing feeder for auxiliaries max. 1.2 kW	X	X	AC	X
N36 Controlled outgoing feeder for auxiliaries max. 2.2 kW	X	X	AC	X
N37 Controlled outgoing feeder for auxiliaries max. 3.5 kW	X	X	AC	X
N38 Controlled outgoing feeder for auxiliaries max. 4.5 kW	X	X	AC	X
N40 Internal control cabling with SIS (Synthetic Insulated Switchboard) wire	–	–	E	–
N44 Make-proof grounding switch at drive input	E	X	E	E
N45 Make-proof grounding switch at drive output	E	X	E	E

Options	Location			
	China	Germany	USA	Brazil
N50 Internal cabling with halogen-free cables	E	X	E	E
N75 Power supply for external devices 24 V	–	–	–	E
N77 18-pulse transformer (9-cell drives only)	X	–	–	E
N94 Grounding studs	X	X	X	X
P				
P30 No approval; full release to manufacturing (A0)	X	X	X	X
P31 Control I/O approval only; full release to manufacturing (A1)	X	X	X	X
P33 Full drawing approval; all drawings provided in advance; hold point (A3)	–	X	X	X
P40 Transformer assembly lift points outside on cabinet roof	–	–	WC	–
Q				
Q78 3 months extension to a total of 15 months from delivery	X	–	–	–
Q79 6 months extension to a total of 18 months from delivery	X	–	–	–
Q80 12 months extension to a total of 24 months from delivery	X	X	X	X
Q81 18 months extension to a total of 30 months from delivery	X	X	X	X
Q82 24 months extension to a total of 36 months from delivery	X	X	X	X
Q83 30 months extension to a total of 42 months from delivery	X	X	X	X
Q84 36 months extension to a total of 48 months from delivery	X	X	X	X
Q85 48 months extension to a total of 60 months from delivery	X	X	X	X
T				
T03 White phenolic nameplate with black letters	X	X	X	X
T04 Stainless steel nameplate	X	X	X	X
T09 Nameplate, warning labels in English / Danish	E	E	E	E
T12 Nameplate, warning labels in English / Romanian	E	E	E	E
T13 Nameplate, warning labels in English / Bulgarian	E	E	E	E
T14 Nameplate, warning labels in English / Turkish	E	E	E	E
T15 Nameplate, warning labels in English / Greek	E	E	E	E
T16 Nameplate, warning labels in English / Dutch	E	E	E	E
T17 Nameplate, warning labels in English / Estonian	E	E	E	E
T18 Nameplate, warning labels in English / Latvian	E	E	E	E
T19 Nameplate, warning labels in English / Lithuanian	E	E	E	E
T20 Nameplate, warning labels in English / Slovakian	E	E	E	E
T21 Nameplate, warning labels in English / Finnish	E	E	E	E
T22 Nameplate, warning labels in English / Slovenian	E	E	E	E
T23 Nameplate, warning labels in English / Norwegian	E	E	E	E
T24 Nameplate, warning labels in English / Swedish	E	E	E	E
T25 Nameplate, warning labels in English / Czech	E	E	E	E
T26 Nameplate, warning labels in English / Hungarian	E	E	E	E
T58 Nameplate, warning labels in English / French	E	E	E	E
T60 Nameplate, warning labels in English / Spanish	E	E	E	X
T74 Nameplate, warning labels in English / German	X	X	X	E
T76 Nameplate, warning labels in English	X	X	X	X
T80 Nameplate, warning labels in English / Italian	E	E	E	E
T82 Nameplate, warning labels in English / Portuguese	X	X	X	X
T85 Nameplate, warning labels in English / Russian	X	X	X	E
T86 Nameplate, warning labels in English / Polish	E	E	E	E
T90 Nameplate, warning labels in English / Japanese	E	E	E	E
T91 Nameplate, warning labels in English / Chinese	X	X	X	E
U				
U01 Version with UL listing	–	–	X	–
U02 Version with CE conformance	X	X	X	X
U03 Version with CSA conformance	–	–	X	–
U04 EAC certificate	X	E	E	E
U05 NBR compliance for Brazil	–	–	–	X
U08 Version with UKCA conformance	X	X	X	X
U10 Process Tolerant Protection Strategy - ProToPS™	X	E	E	X
U11 Advanced cell bypass	X	X	X	X

Options	Location			
	China	Germany	USA	Brazil
U13 One redundant cell per phase	–	E	AC E	X
U21 N+1 cell redundancy	–	–	WC	–
U22 N+2 cell redundancy	–	–	WC	–
U57 High temperature	E	E	X	X
U58 Elevated BIL	X	E	E	E
U60 High altitude ≤ 1500 m (5000 ft) at 40 °C	X	X	X	X
U61 High altitude ≤ 2000 m (6600 ft) at 40 °C	X	X	X	X
U62 High altitude ≤ 2500 m (8200 ft) at 40 °C	E	E	E	E
U63 High altitude ≤ 3000 m (10000 ft) at 40 °C	E	E	E	E
U64 High altitude ≤ 3500 m (12000 ft) at 40 °C	E	E	E	E
U65 High altitude ≤ 4000 m (13300 ft) at 40 °C	E	E	E	E
V				
V01 2.3 kV motor voltage	X	–	AC	X
V02 2.4 kV motor voltage	X	–	AC	X
V03 3.0 kV motor voltage	X	–	AC	X
V04 3.3 kV motor voltage	X	–	X	X
V05 4.0 kV motor voltage	X	–	X	X
V06 4.16 kV motor voltage	X	–	X	X
V07 4.8 kV motor voltage	X	–	X	X
V08 5.0 kV motor voltage	X	–	X	X
V09 5.5 kV motor voltage	X	–	X	X
V10 6.0 kV motor voltage	X	X	X	X
V11 6.3 kV motor voltage	X	X	X	X
V12 6.6 kV Motor Voltage	X	X	X	X
V13 6.9 kV motor voltage	X	X	X	X
V14 7.2 kV motor voltage	X	X	X	X
V15 8.0 kV motor voltage	–	–	X	–
V18 10.0 kV motor voltage	X	–	X	–
V19 11.0 kV motor voltage	X	–	X	–
V26 9.8 kV motor voltage	X	–	X	–
W				
W03 Bottom entry of coolant piping	–	–	WC	–
W05 Coolant cabinet high capacity expansion tank	–	–	WC	–
W32 Advanced cooling cabinet	–	–	WC	–
W35 Liquid-to-air heat exchanger control panel mounted on outside of the cooling cabinet	–	–	WC	–
W41 Drive prepared for air-to-air heat exchanger	–	–	AC E	–
W51 Mechanical two-way inlet water temperature regulating valve	–	–	WC	–
W52 Mechanical three-way inlet water temperature regulating valve	–	–	WC	–
W55 Prepared for inlet water filter for low-quality water	–	–	WC	–
W71 Deionized water provided by Siemens	–	–	WC	–
W72 Propylene glycol provided by Siemens	–	–	WC	–
Y				
Y05 Customer-specific nameplate	X	X	E	X
Y09 Paint finish other than standard	X	X	E	X
Y10 Circuit diagrams with customer-specific description field.	X	X	E	X
Y15 Output filter	E	E	E	E
Y18 Automatic restart	–	–	E	E
Y19 Automatic and remote fault reset	–	–	E	E
Y36 Customer-specific cabinet labels	–	X	X	X

1) For drives manufactured in the USA, the input snubber (L36) is standard for input voltages above 10 kV

Option descriptions

Availability options

Option	Description
U11	<p>Advanced cell bypass</p> <p>Cell bypass provides a higher level of system availability and process reliability. In less than a quarter of a second (250 ms), the drive can bypass failed cells and maintain a balanced output voltage. With one cell in bypass, the drive still produces sufficient voltage to allow the process to continue uninterrupted, and the quality of the voltage and the waveform remain virtually unchanged.</p> <p>To ensure the most reliability and availability, the VFD is equipped with mechanical cell bypass with independent power supply and control communication. This cell bypass can be tested and demonstrated during witness testing.</p> <p>Loss of cells reduces the drive's power capability; torque is reduced only when the drive's power capability exceeds the designed limit. Faulted cells can be replaced at a convenient planned maintenance window.</p> <p>For some applications with low load inertia, such as an ESP, during the cell bypass the speed may rapidly decelerate. In such applications where a process trip may be issued by the system control, use of manual cell bypass is recommended.</p> <p>Manual cell bypass is configured in the drive operating system. When a cell fault occurs, the drive will trip on the cell fault. The user can reset the fault, which triggers a cell bypass, and can then proceed to re-start the drive. The reset can be done through plant HMI or SCADA.</p>

Option	Description
U10	<p>Process Tolerant Protection Strategy - ProToPS™</p> <p>With a proven record of 99.99 percent process uptime, ProToPS™ protects the customer process from faulty sensors or data. ProToPS™ offers a proactive control strategy for applications where failure avoidance is critical. It provides a hierarchical system of warnings in advance of potential drive system trip. This control strategy allows time for the operator to evaluate the situation and respond appropriately to avoid a system shutdown.</p> <p>This option requires advanced cell bypass (option U11) and redundant blower (option M61) for maximum performance.</p>

Option	Description
M61	<p>Redundant blower</p> <p>To improve system availability, an additional blower is added to the air-cooled drive. If a blower fails, the cooling system is automatic switched over to redundant blower to ensure uninterrupted drive operation. A fan alarm fault will be annunciated. This prevents production down time or disruptions.</p>

Option	Description
L53	<p>UPS for power supply of the control</p> <p>In the instances where UPS back up for low voltage network is not available on site, the drive can be equipped with a UPS to maximize up time during low voltage power interruptions. The UPS provides back up power for the drive control and is configured for a buffer time of up to 8 min.</p>

Note: Option L53 is available for 120 V or 220 V AC only.

Option	Description
L85	<p>Redundant control power (for water cooling only)</p> <p>This option provides a second low voltage network control input with automatic switch over to prevent unnecessary interruptions and down time in case the first low voltage supply fails. This option includes UPS.</p>

Note: Option L85 is available for water-cooled drives only and requires an additional cabinet.

Cell redundancy

Processes that cannot tolerate a reduction in drive power when one or more cells are in bypass should select the cell redundancy option. This option significantly increases drive availability when long intervals between services are required. This option is scalable depending on your process requirements. Cell Redundancy options require cell bypass.

Option	Description
U13	<p>One redundant cell per phase (for air cooling only)</p> <p>Option U13 provides full output power with a bypassed cell in each phase. This option adds extra three cells to the drive (i.e. one cell per phase).</p>
Note:	<p>Option U13 requires cell bypass (U11) and redundant blower (M61).</p> <p>Not available for output voltages 6.6, 6.9, 7.2, 11 kV.</p>
U21	<p>N+1 cell redundancy (for water cooling only)</p> <p>Option U21 provides rated power operation with one cell bypassed.</p>
Note:	<p>Option U21 requires cell bypass option (U11) and redundant pump. Not available with all output voltages. For details, please contact your Siemens sales partner.</p>
U22	<p>N+2 cell redundancy (for water cooling only)</p> <p>Option U22 provides rated power operation with two cells bypassed.</p>
Note:	<p>Option U22 requires cell bypass option (U11) and redundant pump. Not available with all output voltages. For details, please contact your Siemens sales partner.</p>

Safety options

Option	Description
K86	<p>Safe Torque Off (STO)</p> <p>The option K86 provides an efficient electronically based "Safe Torque Off" (STO) sub function which can be easily integrated into a completed machine's Safe Torque Off safety function.</p> <p>The safety related STO function is a mechanism for preventing the drive from unexpectedly starting according to EN 60204-1:2006/A1:2009, Section 5.4. The function is integrated in the drive and is independent of the converter operating functions. It is used in conjunction with a machine function – or in the case of a fault – to disconnect the torque-generating energy feed to the motor in a safety-related fashion.</p> <p>There are two independent switch-off signal paths, which are both failsafe (low-active). This ensures that when a component fails or a cable is interrupted, the system always goes into the safe state.</p> <p>The following points apply when the STO function is selected:</p> <ul style="list-style-type: none"> • The motor cannot inadvertently start. • The torque-generating energy feed to the motor is safely interrupted because of the safety-related pulse cancellation. • VFD output is not electrically disconnected. <p>The STO function is certified in accordance with IEC 61800-5-2 with a safety integrity level (SIL) of up to 3 with a hardware fault tolerance (HFT) of 1 as defined in IEC 61508. STO meets EN ISO 13849-1:2015 Safety Category 3 Performance Level e.</p>

Option	Description
A76	<p>System arc detection</p> <p>To provide additional protection, the SINAMICS PERFECT HARMONY GH180 IQ drive has the arc detection system option. Optical arc flash detection sensors are located in each power cell and transformer cabinet. In the rare arc fault event, the signal will be sent directly to the upstream protection device and the drive will de-energize as quickly as possible.</p>

Option	Description
M57	<p>Arc resistant design 40 A to 430 A</p> <p>Arc resistant option is designed to help minimize the risks associated with an arcing fault and provides increased protection of customers' personnel and equipment.</p> <p>The equipment is designed to withstand or mitigate the effects of an internal arcing fault as indicated by an appropriate label meeting the test requirements of the following:</p> <ul style="list-style-type: none"> • IEC 62477-2 • Associated protection required (fuses) • The details regarding associated protection used shall be provided by the manufacturer in the documentation. <p>This product successfully passed the following testing criteria:</p> <ul style="list-style-type: none"> • Type Accessibility – Type 2A • Classified sides of the enclosure – Front (F), Lateral (L), Rear (R) • Rated arc fault current (I_A) – 50 kA up to 13.8 kV • Rated arc fault duration (t_A) – 500 ms • Frequency – 50/60 Hz <p>Associated protection: External fuses; general purpose current-limiting fuses. The customer is responsible for procuring and installing fuses based on Siemens requirements.</p> <p>Note: Available for 6SR52, 40-260A (Phase 1A, 2A, 3A, 2B and 3B) and 340-430A Phase 4A). Not available if input fuses are > 450E. For other ratings, please contact your Siemens sales partner. Option M57 is only available for air-cooled drives.</p>



Door interlocks

SINAMICS PERFECT HARMONY GH180, 6SR5 drives are designed with bolted covers as a standard option. For customers that would like to have keyed access, there are 4 types of mechanical interlocks available depending on customer preference. Safety closing/interlocking system is based on the key transfer system.

Typically, the circuit breaker is opened, and a feeder earthed to release a key to the drive key exchange unit which in turn releases the keys to the cabinet bolted covers of the power section(s). This ensures that the drive is isolated from the input medium voltage and that the medium voltage is no longer present. The number of keys will depend on the number of cabinets.

Option	Description
M08	Superior - mechanical door interlocks
M09	Kirk - mechanical door interlocks
M10	Castell - mechanical door interlocks
M38	Fortress - mechanical door interlocks
M46	INDAC - mechanical door interlocks
M12	Electrical door interlocks
	The electrical door interlock system prevents access to the energized sections in the drive as long as hazardous voltages are present. This system also prevents the drive from being switched on until all doors of the energized sections in the drive are closed.
Note:	GH180 air-cooled as a default is supplied with M09, Kirk key interlocks in North America or M12 electrical door interlocks in Europe and China.

Option	Description
N10	Prepared for input contactor
	Input contactor allows customers to isolate medium voltage drive for maintenance or repairs purposes without disconnecting primary protection. This option is recommended when multiple medium voltage drives are installed at the single site connected to common upstream protection. The benefit of an input contactor is that it is capable to break full current while input disconnect only can be opened after primary protection is opened.
	Selecting this option will add switchgear to the drive on the side. When option N10 is chosen, the appropriate switchgear sizing is automatically selected based on the other drive parameters.
Note:	The input contactor option is available when the primary input voltage is less than 7.2 kV.

Option	Description
N13	Prepared for input circuit breaker
	Input contactors are only available for input voltage up to 7200V. When input voltage exceeds this, a circuit breaker is an appropriate solution.
	Selecting this option will add switchgear to the drive on the side. When option N13 is chosen, the appropriate switchgear sizing is automatically selected based on the other drive parameters.

Option	Description
N94	Grounding studs
	This option provides protective grounds to create an electrically safe work condition during maintenance. The ground studs will be installed in the following locations: Input and output power terminations and ground pads. The terminations will be equipped with a ball type ground stud.
Note:	Grounding cable and/or clamps are not included

Option	Description
N44	Make-proof grounding switch at drive input
	With option N44, a grounding switch is installed at the drive input. The switch connects each phase to ground to prevent unexpected reconnections during maintenance.
	For safety reasons, the drive control locks the ground switch open (OFF) using electromagnetic interlocks until the drive input voltage is removed (OFF) and 10 min have passed to allow the power cell capacitors to discharge; only then can the ground switch be closed (ON). The control is integrated into the protection and monitoring circuit of the drive.
	In the event of maintenance work on the drive, it must be ensured on the plant side that there is no external voltage present, e.g. auxiliary voltage for blowers, the cooling system, controller and closed-loop control and any external drive outputs.
Note:	This option for 9 cell air-cooled configuration requires an additional cabinet

Option	Description
N45	Make-proof grounding switch at drive output
	With option N45, a grounding switch is installed at the drive output. Some applications (ex: gas turbines or permanent magnet motor) may regenerate and feed energy back to the drive. In such instances, a make-proof grounding switch is recommended. The switch connects each phase to ground to prevent unexpected voltage during maintenance.
	For safety reasons, the drive control locks the ground switch open (OFF) using electromagnetic interlocks until the drive input voltage is removed (OFF) and 10 min have passed to allow the power cell capacitors to discharge; only then can the ground switch be closed (ON). The control is integrated into the protection and monitoring circuit of the drive.
Note:	This option for 9 cell air-cooled configuration requires an additional cabinet
	Options N44 and/or N45 are recommended for applications within Europe.

Control and display Instruments

Option	Description
A30	Touchscreen with standard cable Standard Siemens touchscreen with standard Ethernet cable will be provided on the door of the drive. Standard HMI shall be loaded with ToolSuite software only.
Note:	Air-cooled 9-cell configuration and all water-cooled drives require an additional cabinet

Control selector switches and push buttons

These switches provide the operator with the flexibility to select preferred drive control mode: local through keypad, remote/auto control through digital inputs or serial communication.

Option	Description
K29	Pushbutton / Potentiometer kit With option K29, a pushbutton kit is located on the control door. It includes <ul style="list-style-type: none"> • a start and a stop pushbutton • a fault reset button and a manual speed potentiometer Emergency Stop pushbutton is standard.
K31	Off-Local-Remote selector switch Option K31 provides the ability to choose between off, local control and remote control of the three position selector switch mounted on the control door.
K32	Off-Hand-Auto selector A three-position selector switch mounted on the control door.
K33	Keyed Off-Local-Remote selector It offers the same functionality as option K31 but this option provides additional protection as it requires keys (password) to change the position.
K34	Keyed Off-Hand-Auto selector It offers the same functionality as option K32 but this option provides additional protection as it requires keys (password) to change the position.
Note:	Option K31 is the default configuration.

Option	Description
L50	Cabinet lighting and service socket outlet This option includes a universal lamp and a service socket outlet (Schuko version) installed in the control cabinet. The voltage supply for the cabinet lighting and socket outlet (on terminal block) is provided externally. The cabinet lighting is switched on manually via a switch.
Note:	This option for 9 cell air-cooled configuration requires an additional cabinet. Air-cooled option only.

Auxiliary and control voltage supply

Option	Description
K69	Control voltage by Siemens This option provides control voltage that is generated internally from the auxiliary supply.
K68	Control voltage 220/230/240V AC by customer Using option K68, the customer will supply control voltage to the drive. Typical current consumption is 8 A. The internal control voltage will be 120 V AC in any case. For water-cooled drives, it requires an additional cabinet.
K73	I/O signal voltage 24 V DC This option provides 24 V DC that is available as I/O control signals.
K79	Control voltage 120 V AC by customer The customer will provide control voltage to the drive

Signal lamp and display instruments

Signal lamps and display instruments are hardwired options that provide quick visual display of drive performance and health. The same parameters are also available through the drive HMI.

Option	Description
K20	Signal lamp in the cabinet door With option K20, five signal lamps that display the operating status of the drive are provided in the cabinet door of the control section. <ul style="list-style-type: none"> • Fault (red) • Alarm (yellow) • Operation (green) • Drive ready (white) • Local operation (white)
K21	Display instruments for voltage, current and speed For display of process variables, analog display instruments are installed in the cabinet door indicating the measured value in %: <ul style="list-style-type: none"> • Motor current (0 to +120 %) • Motor speed (-120 % ... 0 ... +120 %) • Motor voltage (0 to +120 %)
Note:	For manufacturing location USA, K21 option requires additional cabinet.

Controlled outgoing feeder for auxiliaries

This option provides a control of outgoing feeder for the operation of external auxiliary equipment, e.g. separate blowers on the motor, anti-condensation heating for the motor or pump/oil supplies. It is controlled and protected by motor circuit-breakers. The contactor is switched on with the ON command at the drive and switched off with the OFF command. Should local regulations require earth leakage protection then that is done from the external feeder supply.

Option	Description
N30	Controlled outgoing feeder for auxiliaries 400 V 3 AC, 50 Hz, max. 4 kW 469 V / 480 V 3 AC, 60 Hz, max. 4.8 kW ($\cos \phi = 0.8$; setting range of motor circuit-breaker from 9 A to 12.5 A).
N31	Controlled outgoing feeder for auxiliaries 400 V 3 AC, 50 Hz, max. 7 kW 469 V / 480 V 3 AC, 60 Hz, max. 8 kW ($\cos \phi = 0.8$; setting range of motor circuit-breaker from 14 A to 20 A).
N32	Controlled outgoing feeder for auxiliaries 400 V 3 AC, 50 Hz, max. 11 kW 469 V / 480 V 3 AC, 60 Hz, max. 12.7 kW ($\cos \phi = 0.8$; setting range of motor circuit-breaker from 18 A to 25 A).
N33	Controlled outgoing feeder for auxiliaries 400V, 3 Φ AC, 50Hz, max. 15kW 469 V / 480 V, 3 AC, 60 Hz, max. 17.5 kW ($\cos \phi = 0.8$; setting range of motor circuit-breaker from 28 A to 40 A).
N35	Controlled outgoing feeder for auxiliaries 110/120 or 220/240 V 1 AC, max. 1.2 kW
N36	Controlled outgoing feeder for auxiliaries 110/120 or 220/240 V 1 AC, max. 2.2 kW
N37	Controlled outgoing feeder for auxiliaries 110/120 or 220/240 V 1 AC, max. 3.5 kW
N38	Controlled outgoing feeder for auxiliaries 110/120 or 220/240 V 1 AC, max. 4.5 kW
Note:	These options for 9 cell air-cooled configuration require an additional cabinet.

Option	Description
N75	Power supply for external devices 24 V DC With option N75 the drive is delivered with a power supply unit for 24 V DC auxiliaries. It provides 6 output terminals each for +24 V and 0 V. The total power consumption across all output terminals is limited to 2.5 A.

Option	Description
L55	Anti-condensation heating for cabinet Anti-condensation heaters are recommended at low ambient temperatures and high levels of humidity to prevent condensation. The number of cabinet heaters fitted depends on the number of cabinet panels. The anti-condensation heaters are controlled with a thermostat.

Note: This option includes over-temperature protection. The supply voltage for the anti-condensation heating (110/120 or 220/240 V AC) must be supplied externally. Should local regulation require earth leakage protection then that is done from the external feeder supply. If drives are placed in storage for any period of time, Siemens recommends anti-condensation heaters. The number of heaters depends on the size and quantity of cabinets in the drive.

Heat management options

Option	Description
W41	Drive prepared for air-to-air heat exchanger When this option is purchased, the drive is equipped with necessary plenums to ensure proper drive airflow when connected to the heat exchanger. The drive comes with the heat exchanger control box. All heat exchanger fan motors are wired to the control box and can be either mounted on the side of the drive or outside on the heat exchanger itself in the NEMA 4 enclosure.
Note:	The heat exchanger is standalone equipment specified and provided by Siemens. It is enclosed in polycoated housing with fans for N+1 redundancy. The enclosure includes a top hat that directs the outside air horizontally out of the top of the unit. The top contains louvers to prevent a draft when the fans are not running. The heat exchanger requires outdoor installation by others. The heat exchanger can include optional provisions, such as integral space heaters and motor/fan assemblies designed for low ambient operation at up to -40° C.

Option	Description
M64 M68	<p>Drive prepared for duct flange connection in front/rear</p> <p>With these options, the drive is prepared for connection to an external exhaust air system, which shall connect to the front (M64) of the blower assembly or to the rear (M68) of it. Only one of the options per drive.</p> <p>These options are applicable when the customer is providing external exhaust ducting to carry the hot air blowing out of the drive cabinet outside the room.</p> <p>When configuring the exhaust air ducts for the drive ventilation system, it is essential to ensure that the air flow rates stipulated in the drive data sheets or drawings are observed. The pressure drop between the air inlet and the air outlet of the drive is different for different configurations.</p> <hr/> <p>Note: The following requirements shall be met when connecting to external air duct:</p> <ul style="list-style-type: none"> • Provide openings in the air duct to allow for the blowers' maintenance. • After fitting the air duct, the cabinet doors must still be able to be opened and closed for maintenance purposes. <p>This option can affect the values for sound pressure level depending on the design of the exhaust air system. For more details, please contact your Siemens sales partner.</p>

Synchronous transfer options

Option	Description
L29	<p>Bidirectional synchronized transfer</p> <p>Option L29 provides the capability for synchronized, seamless transfer of the one motor to the line and take-over of the motor from the line. Before connecting the motor to the line, the converter synchronizes the motor to the supply/utility voltage phase, frequency and amplitude. Most applications do not require output reactor.</p> <p>Output reactor should be considered when the following conditions are present:</p> <ul style="list-style-type: none"> • Excessive system short circuit current ratings • Excessive torque variations during steady state operation, and • Extremely low motor/load inertia <hr/> <p>Note: The circuit-breakers/contactors are not included in the scope of delivery. A motor protection relay should also be considered in the bypass circuit by the customer.</p>

Option	Description
N17	<p>Bidirectional synchronized transfer of one motor, switchgear provided by Siemens</p> <p>Selecting this option, in addition to synchronous transfer control function, it will add switchgear to the drive lineup. The appropriate switchgear is selected and sized automatically based on the drive parameters.</p> <hr/> <p>Note: Reactor-less bidirectional synchronized transfer is default. Option L09 must be selected if requested by the customer.</p> <p>A motor protection relay (MPR) is part of the scope and installed in the bypass circuit. Siemens integrates an MPR with associated CTs and PTs into the switchgear line-up. Customer is responsible for programing the MPR.</p>

Option	Description
L09	<p>Output reactor</p> <p>Depending upon the installation or application an output reactor may be required for bidirectional synchronized transfer. The output reactor decouples the converter output during the transfer process.</p> <p>For air-cooled drives the output reactor cabinet can be ether included in the drive lineup with the same degree of protection as the drive or housed in a separate NEMA 3R/IP14 cabinet designed for outdoor installation.</p> <p>For water-cooled units, the water-cooled reactor cabinet will be included in the drive lineup with IP protection same as power section of the drive.</p>

Option	Description
N18	<p>Bidirectional synchronized transfer of multiple motors, switchgear provided by Siemens</p> <p>With this option in addition to the Sync Transfer Control system, Siemens will add switchgear to the drive based on the number of motors handled by the drive and system setup. When option N18 is selected, the appropriate switchgear sizing is automatically selected based on the drive parameters. Siemens can provide switchgear based on the customer preferred manufacturer.</p> <hr/> <p>Note: When a customer selects synchronous transfer option Siemens recommends customers to install a MPR. This option integrates an MPR with associated CTs and PTs into the switchgear line-up. Customer is responsible for programing the MPR.</p>

Option	Description
L20	<p>Bidirectional synchronized transfer of multiple motors, switchgear provided by customer</p> <p>In the cases where the customer either has already all required switchgear or prefers to procure their own equipment, Siemens offers just the Sync Transfer Control system (STC) which provides for the synchronous transfer of two to eight motors directly to or from a line source of power. The system is designed to handle induction motors or synchronous motors and connection of motors to a source the same as the drive or to an alternate source. The STC has a local color HMI to support the configuration and status of the system. The STC can be mounted in the options cabinet, switchgear (if space available) or a separate enclosure. The synchronous transfer control logic can be demonstrated during the witness test.</p>

Note: When customers select synchronous transfer option Siemens recommends customers to install motor protection relay (MPR). Once a motor is transferred directly on line it is no longer protected by the VFD. When switchgear is supplied by a customer, it is the customer responsibility to install and program the MPR.

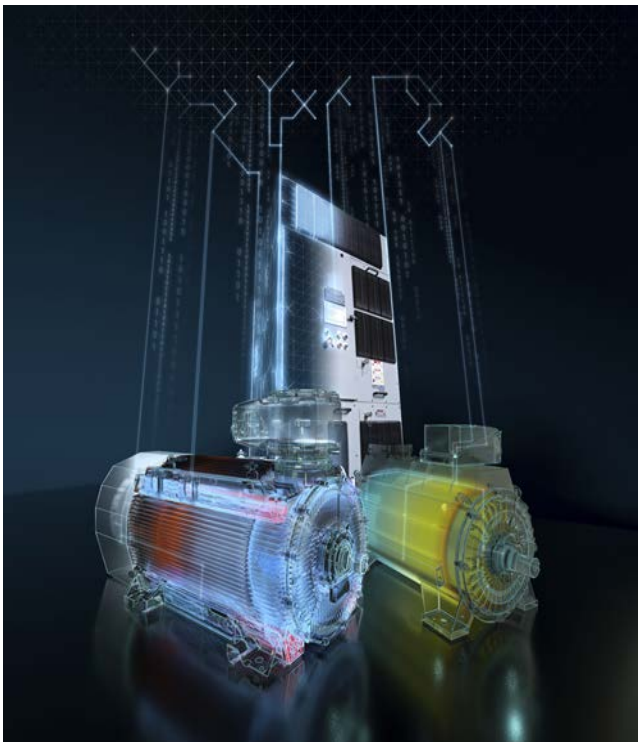

Motor protection, monitoring and meters

Motor temperature monitoring and protection systems by other manufacturers

Option	Description
A59	<p>PEXTRON 8 channel RTD monitor</p> <p>A device installed in the drive to monitor motor temperature in windings and/or bearings. Basic 8-channel RTD monitor includes Modbus RTU communication protocol.</p>
A60	<p>TEC System 8 channel RTD monitor</p> <p>A device installed in the drive to monitor motor temperature in windings and/or bearings. Basic 8-channel RTD monitor.</p>
A80	<p>TEC System 12 channel RTD monitor</p> <p>A device installed in the drive to monitor motor temperature in windings and/or bearings. Basic 12-channel RTD monitor.</p> <p>Communication Protocol: None (default) RS 485 Modbus (option)</p>
Note:	Customer is responsible for RTD programming. If other protocols are required, please contact your Siemens sales partner.

Option	Description
L81	<p>2 x 2 thermistor protection relays</p> <p>Option L81 includes four thermistor protection relays for PTC thermistors (type A) for alarm and trip. The power supply for the relay and the evaluation is provided in the drive.</p>
L82	<p>3 x 2 thermistor protection relays</p> <p>Option L82 includes six thermistor protection relays for PTC thermistors (type A) for alarm and trip. The power supply for the relay and the evaluation is provided in the drive.</p>
L89	<p>Pt100 evaluation unit with 6 inputs for ex-proof motors and 6 analog outputs</p> <p>For use in explosion-proof motors, Zone 2, Zone 22 (non-conductive dusts) Div. 2, and nonhazardous zones, six evaluation units are available.</p> <p>Marking, explosion protection: II (1) GD (Eex ia) IIC/IIB and II 3 G Eex nAC II T4.</p>
L91	<p>2 Pt100 evaluation units with 3 inputs each</p> <p>Each Pt100 unit can monitor up to three sensors. For all three sensors, the limits for alarm and trip must be set centrally. The output relays are integrated into the internal fault and shutdown circuit of the drive.</p>

Option	Description
L93	<p>Pt100 evaluation unit with 6 inputs and 2 analog outputs</p> <p>The Pt100 evaluation unit can monitor up to six sensors. The limit values can be programmed by the user for each channel. In the standard setting, the measuring channels are divided into two groups of three channels each. With motors, for example, three Pt100 can be monitored in the stator windings and two Pt100 in the motor bearings. Channels that are not used can be suppressed using appropriate parameter settings.</p> <p>The output relays are integrated into the internal fault and shutdown circuit of the drive. There are two programmable analog outputs available (0/4 mA to 20 mA and 0/2 V to 10 V).</p>

Option	Description
A82	<p>SEL 710 motor protection relay</p> <p>Full featured high-end motor protection/management relay with miscellaneous sensors monitoring capability installed.</p> <p>Communication Protocol:</p> <ul style="list-style-type: none"> • none (default) • RS 485 Modbus (option) <p>Includes output phase CTs and PTs.</p>
A83	<p>Multilin 869 motor protection relay</p> <p>Full featured high-end motor protection/management relay with miscellaneous sensors monitoring capability installed.</p> <p>Communication Protocol:</p> <ul style="list-style-type: none"> • None (default) • RS 485 Modbus (option) <p>Includes output phase CTs and PTs.</p>
Note:	<p>These options for 9-cell air-cooled configuration and water-cooled drives require an additional cabinet.</p>

Customer communication, interface and control software options

Communication options

As a default the SINAMICS PERFECT HARMONY GH180 drive provides an interface for our ToolSuite software that allows monitoring and configuring of the drive from a PC running windows operating system. Serial communication protocols and network communication are offered as options.

SINAMICS PERFECT HARMONY GH180 provides a wide range of protocols to meet customer requirements. As an option, customers may select an additional independent fieldbus as a backup (two networks maximum) in case the first communication network fails to avoid unnecessary interruptions.

The supported fieldbus protocols and drive control provide the capability to monitor up to 64 different drive and motor parameters according to the customers' application and specification. They can select from more than 200 parameters and variables available in the system.

Serial communication

Option	Description
G22	Modbus RTU interface, network 1 RS 485
G23	DeviceNet profile 12 interface, network 1
G28	Modbus Ethernet interface, network 1
G91	PROFIBUS DP interface, network 1
G37	EtherNet/IP interface, network 1
G32	Modbus RTU interface, network 2
G34	PROFINET, network 1
G38	Modbus Ethernet interface, network 2
G39	EtherNet/IP interface, network 2
G43	DeviceNet profile 12 interface, network 2
G93	PROFIBUS DP interface, network 2

Network communications

Option	Description
G41	Ethernet network switch without fiber optic port
G42	Ethernet network switch with fiber optic port
G47	<p>Ethernet port connector mounted on the door</p> <p>This port is used in conjunction with our ToolSuite software that allows one to monitor and configure the drive from a PC running windows operating system.</p>

Monitoring options

Option	Description
A34	<p>Input and output thermal temperature monitoring</p> <p>Thermal monitoring of the drive's input and output connections ensures that in rare case that the connection(s) becomes loose or becomes too hot for other reasons, the operator can initiate a maintenance check to prevent any damage to the equipment.</p> <p>Following features are included:</p> <ul style="list-style-type: none"> • Monitor and compare temperature trends • Set up an alarm and trip levels <p>This feature eliminates need for infrared windows and manual measurements.</p>

Option	Description
A95	<p>Environmental condition monitoring</p> <p>Preventive maintenance is an established routine of regularly inspecting equipment to look for and fix issues before they turn into major problems. Siemens offers the environmental condition monitoring functionality to ensure the drive operates within design parameters. This option will alert the user of potential issues causing operation outside the normal conditions and the risk of a potential failure. PERFECT HARMONY IQ power cells are included and offer the following features.</p> <ul style="list-style-type: none"> • Ambient temperature • Cell capacitance • Humidity monitoring • Dew point calculation • Pressure monitoring <p>Benefits:</p> <ul style="list-style-type: none"> • Replaces pre-defined time-based maintenance with specialized condition-based maintenance • Provides early detection and warning of abnormal operating conditions • Reduces planned downtimes based on real-time drive and process data • Extends service life of components and machines • Increases system availability • Protects total solution in the environment <p>This feature is available through SIDRIVE IQ (option C68).</p>

Option	Description
C68	<p>SINAMICS CONNECT 500</p> <p>Using SIDRIVE IQ, the relevant data of the drive systems can be easily accessed at any time and from anywhere, to be digitally monitored, analyzed and optimized. As a consequence, the status and operating data of the drive components are transparent; maintenance requirements and optimization potential can be identified.</p> <p>To use SIDRIVE IQ, MV drives and HV motors must be equipped with the SINAMICS CONNECT 500 or SIMOTICS CONNECT 600 connectivity modules.</p> <p>For SINAMICS PERFECT HARMONY GH180, in the standard version, the matching SINAMICS CONNECT 500 connectivity is integrated in the closed-loop control section via the already pre-selected option C68. Important operating parameters of the closed-loop converter control – for example that indicate the state, the temperature, the load and the status messages – are transferred to the SIDRIVE IQ digital platform for analysis via a secure, encrypted data link.</p> <p>SINAMICS CONNECT 500 provides the basis to establish a link with the SIDRIVE IQ digital platform to be able to utilize the many associated advantages!</p> <p>Additional information on SIDRIVE IQ is provided in the Internet at innomotics.com/sidrive-iq.</p>



Option	Description
K50	<p>Closed loop vector control with provision for speed encoder</p> <p>This option allows for integration of an encoder signal feedback into the drive control through I/O. It is used in applications that require accurate speed control, especially at low speeds. Speed accuracy is up to 0.1 % rated speed. Power to the encoder is supplied by the VFD. To accomplish an optically isolated encoder design, the customer must install additional components provided by Siemens.</p>
Note:	It is not available for Permanent Magnet Motors. Encoder itself is not part of the scope of supply.

Customer interface

Option	Description
E04	<p>Additional customer analog, digital inputs/outputs (I/O) modules</p> <p>Drive has predefined analog and digital I/O associated with drive operation. Option E04 is offered when the customer process requires additional inputs and outputs. Below are the additional I/O that available with this option:</p> <ul style="list-style-type: none"> • 4 digital inputs • 4 digital outputs • 2 analog inputs • 2 analog outputs <p>Note: For 9-cell air-cooled and water-cooled drives, this option requires an additional cabinet. This option is mutually exclusive with option E06.</p>
E06	<p>Additional customer analog, digital inputs/outputs (I/O) modules</p> <p>Drive has predefined analog and digital I/O associated with drive operation. Option E06 is offered when the customer process requires additional inputs and outputs. Below are the additional I/O that available with this option:</p> <ul style="list-style-type: none"> • 8 digital inputs • 8 digital outputs • 4 analog inputs • 4 analog outputs <p>Note: This option is mutually exclusive with option E04.</p>



Control software options

Option	Description
E03	<p>Control of Permanently Excited Motor</p> <p>With this option permanent magnet motor (PMM) control feature is enabled to ensure proper starting sequence.</p> <p>In addition to special starting requirements, the SINAMICS PERFECT HARMONY GH180 control scheme offers additional capabilities on request:</p> <ul style="list-style-type: none"> • Ability to control motor power factor • Ability to provide overspeed operation when required

Note:  Danger, high voltage may be present that could cause injury or death

Due to the use of a rotor with permanent magnets any rotation of the shaft will induce voltage on the motor terminals. This has several implications:

- Precautions must be taken to ensure there is no voltage induced on the motor terminals.
- Equipment such as Variable Frequency Drives (VFD) must be applied such that power flow back from the motor will not damage equipment.
- The selected VFD must be able to tolerate the highest possible voltage which could be generated by a spinning PM motor. This is especially important for ESPs which may backspin after shutdown or motors operated in overspeed

Output contactor may be required.



Option	Description
Y18	<p>Automatic restart</p> <p>After the ride-through interval is over (500 ms with all cells functioning and 100 ms with cell in bypass), automatic restart option switches the drive on again when the medium voltage is restored. The drive then ramps up the motor to the current speed setpoint. The control power has UPS back up supplied by the customer. If UPS back up is not available, L53 options can be provided by Siemens.</p> <p>With this option drive will have the following control logic: if medium voltage is gone during drive operation and returns within 10 minutes the drive will automatically restart.</p> <p>For the drives:</p> <ul style="list-style-type: none"> • Without pre-charge: once the cell diagnostics is completed, and no other faults were found the drive will restart. • With pre-charge: customer is required to provide status of MV availability • Automatic restart will not get engaged if power is not available for longer than 10 minutes. <p>This option shall be hard-key or password protected to avoid unwanted changes by unauthorized personnel.</p>

Y19	<p>Automatic and remote fault reset</p> <p>This option includes the following features Automatic and Remote fault reset option will allow customer either automatically or remotely reset to certain non-critical drive internal faults and safely restart the drive. This option provides customer with fault classification based on their severity. The following information will be available to a customer:</p> <ul style="list-style-type: none"> • Local display and classification of faults and alarms. • If a drive experienced the fault and it was reset automatically. • If there is a fault and it is safe to reset remotely. • Or it is recommended to go to the site for inspection prior to fault reset <p>Restart must be initiated by the customer, the drive will accept up to 3 attempts for remote restart within a 5-minute interval, manual intervention is required after that.</p>
------------	--

Option	Description
B09	<p>ESP Application</p> <p>Drive controls configured for Electric Submersible Pump (ESP) applications. Specific drive parameterization for:</p> <ul style="list-style-type: none"> • Backspin detection • Stalled motor detection • Underload protection • Short-circuit protection • Stuck pump and motor release ("rocking" function) • Extended torque power loss ride through (5 cycle – 100 ms)
Note	<p>If the cable length is longer than 2.3 km the output filter parameters are calculated and loaded as filter data (inductance and capacitance) into the drive parameter set.</p>

Mechanical options

Option	Description
M42	IP42 degree of protection As standard, all 6SR5 drives are supplied with IP42 degree of protection. For all other air-cooled drives IP42 is an option.
M53	24" option cabinet 24" cabinet attached to the side of the drive for housing additional hardware as needed.
H03	1000 mm option cabinet 1000 mm cabinet attached to the side of the drive for housing additional hardware as needed.

Gland plates

Gland plates provide access for customer connections to and from the drive. As standard, the gland plates are aluminum.

Option	Description
M29	Painted steel gland plates
M35	Aluminum gland plates
M36	Brass gland plates
M37	Stainless steel gland plates

Cabinet paint options

Option	Description
M92	Munsell N6.5
M97	RAL 7035
M98	ANSI 61
Y09	Paint finish other than standard A special color must be specified in plain text when ordering The cover of the filter mats will have the standard color even though the cabinet has a special paint finish.

Altitude, ambient condition, and transformer options

Option	Description
U57	High temperature Temperatures up to and including 50°C

U58	Elevated BIL Elevated transformer BIL (basic impulse level). This is the next level up from the default BIL value.
------------	--

Due to reduced air density at high altitudes, the VFD requires additional considerations to ensure that it works as designed. Both power section and transformer deratings are required. GH180 can meet these requirements without output voltage compromise – 100 % of voltage available without step up transformer. Our cell boards are designed and tested to operate up to 4000 m.

Option	Description
U60	High altitude ≤ 1500 m (5000 ft) @ 40 °C
U61	High altitude ≤ 2000 m (6600 ft) @ 40 °C
U62	High altitude ≤ 2500 m (8200 ft) @ 40 °C
U63	High altitude ≤ 3000 m (10000 ft) @ 40 °C
U64	High altitude ≤ 3500 m (12000 ft) @ 40 °C
U65	High altitude ≤ 4000 m (13300 ft) @ 40 °C



Option	Description
N26	<p>Synchronized pre-charge and transformer pre-magnetization</p> <p>Remote locations with such weak lines where starting a large VFD can cause a voltage dip, synchronized pre-charge and pre-magnetization of transformer option is recommended. The inrush current is reduced to only 1 to 2 per unit.</p> <p>With option N26, the synchronized pre-charge option is configured and installed. It allows precharge of not only the DC-link capacitors in all power cells, but in addition, to build-up the input transformer flux in close phase relation with the incoming medium voltage feed; hence, minimizing the transformer inrush currents when the circuit-breaker is closed. When the synchronous pre-charge option is selected, a separate auxiliary voltage supply is required by others.</p> <p>This option is only available for water-cooled drives.</p> <p>Note: It is the responsibility of the supplier of the auxiliary feed to ensure the voltage phase difference between the medium voltage feed and the auxiliary feed are within the +/-15 degrees tolerance and that there is the same frequency between the medium voltage input and precharge to allow proper operation of the synchronous precharge.</p>
N77	<p>18-pulse transformer (9-cell drives only)</p> <p>With option N77 an 18-pulse drive transformer is provided for 9-cell drives (standard: 54-pulse).</p>

Option	Description
L36	<p>Input snubber</p> <p>Siemens recommends for the customer to provide a snubber on their existing input breaker to prevent high transients caused by the breaker following IEEE C57.142.</p> <p>If the customer cannot provide an input snubber Siemens can offer it as an option.</p> <p>Note: For drives manufactured in the USA, the input snubber is standard for input voltages above 10 kV.</p>

Cable options

Option	Description
N50	<p>Internal cabling with halogen-free cables</p> <p>With option N50, only halogen-free cables are used for cabling inside the drive. The insulating materials and color coding are in compliance with IEC standards (IEC 62103 and IEC 60204-1).</p> <p>Note: Halogen-free cables are only used on units manufactured in Nuremberg, Germany.</p>

Option	Description
N40	<p>Internal control cabling with synthetic insulated switchboard (SIS) wire</p> <p>SIS wire is provided for the control section and blower control of the drive. It is traditionally used in the environments that require higher level of coating. It has thermosetting insulation which is usually heat resistant, moisture-resistant, and flame-retarding grade. It consists of a stranded copper conductor that is coated with XLP (cross-linked polyethylene) insulation.</p> <p>Note: The standard EPDM (ethylene propylene dienemonomer) cable is replaced with SIS wires in the following parts of the drive: the drive control and blower/pump control sections. DCR rack, cell and bypass pre-manufactured harnessed cables along with power cables are excluded from this option. This is air-cooled drive option only</p>

Nameplate options

Unless specified otherwise, standard is black phenolic nameplate with white letters. Use the following option codes to specify a nameplate other than the standard offering.

Option	Description
T03	White phenolic nameplate with black letters
T04	Stainless steel nameplate

Nameplate, keypad and warning label languages

The options below specify the primary languages used for the drive nameplate, warning labels and keypad selection buttons. The secondary language – always English – is used only on the nameplate and warning labels. It provides an English translation of the information listed.

The respective option has to be selected (mandatory option) if the country of the end customer is an EU country or Turkey.

Option	Description
T09	Nameplate, warning labels in English/Danish Operator panel language in English
T12	Nameplate, warning labels in English/Romanian Operator panel language in English
T13	Nameplate, warning labels in English/Bulgarian Operator panel language in English

Option	Description
T14	Nameplate, warning labels in English/Turkish Operator panel language in English
T15	Nameplate, warning labels in English/Greek Operator panel language in English
T16	Nameplate, warning labels in English/Dutch Operator panel language in English
T17	Nameplate, warning labels in English/Estonian Operator panel language in English
T18	Nameplate, warning labels in English/Latvian Operator panel language in English
T19	Nameplate, warning labels in English/Lithuanian Operator panel language in English
T20	Nameplate, warning labels in English/Slovakian Operator panel language in English
T21	Nameplate, warning labels in English / Finnish Operator panel language in English
T22	Nameplate, warning labels in English/Slovenian Operator panel language in English
T23	Nameplate, warning labels in English/Norwegian Operator panel language in English
T24	Nameplate, warning labels in English/Swedish Operator panel language in English
T25	Nameplate, warning labels in English/Czech Operator panel language in English
T26	Nameplate, warning labels in English/Hungarian Operator panel language in English
T58	Nameplate, warning labels in English/French Operator panel language in English
T60	Nameplate, warning labels in English/Spanish Operator panel language in English
T74	Nameplate, warning labels in English/German Operator panel language in English An operator panel in German is only available in conjunction with option D00 (documentation in German).
T76	Nameplate, warning labels in English Operator panel language in English
T80	Nameplate, warning labels in English/Italian Operator panel language in English
T82	Nameplate, warning labels in English/Portuguese Operator panel language in Portuguese
T85	Nameplate, warning labels in English/Russian Operator panel language in Russian
T86	Nameplate, warning labels in English/Polish Operator panel language in English
T90	Nameplate, warning labels in English/Japanese Operator panel language in English
T91	Nameplate, warning labels in English/Chinese Operator panel language in Chinese
Note:	Please contact your Siemens sales partner for languages different from the ones specified above.

Compliance options

Option	Description
L03	EMC filter CE mark drives require an EMC line filter. With option L03, the filter will be installed downstream from the 3-phase control power disconnect switch.
Note:	Option L03 is required for the CE mark and is included in option U02.
U01	Version with UL listing (for core drive only) With option U01, a drive version for the North American market is supplied. It is approved and listed by the Underwriter Laboratories (UL). It includes option M08 (mechanical door interlocks – Superior). It requires shielded cable and stress cones and 36" transition cabinet.
U02	Version with CE conformance With option U02, a drive version with CE conformity is supplied.
Note:	Drives manufactured in Nuremberg, Germany are supplied with CE conformance
U03	Version with CSA conformance With option U03, a drive version certified by the Canadian Standards Association (CSA) is supplied. Option U03 includes option M08 (mechanical door interlocks – Superior).
U04	EAC certificate With option U04, a drive version in conformance with EAC is supplied.
U08	Version with UKCA conformance With option U08, a drive version in conformance with UKCA is supplied (United Kingdom Conformity Assessed).

Documentation options

The standard documentation is supplied in English. The circuit diagrams / terminal diagrams are available only in English.

If option D00 or one of the options D54 to D95 is ordered, the operating instructions, and safety notes on the drive are delivered according to the ordered language option. The respective option has to be selected (mandatory option) if the country of the end customer is an EU country or Turkey.

The quality documents (e.g. approval, certificates, etc) and the technical documents (e.g. circuit diagrams, dimensional drawings, etc) are only available in English or German. Supplementary documentation for the components installed in the drive (provided by the manufacturers of these components) is included on the CD-ROM in English/German. For technical reasons, it is not possible to provide this supplementary documentation for only the options that the customer has ordered.

Please contact your Siemens sales partner for documentation in a language different from the ones specified below.

On customer request, Siemens will provide documentation in the language required as an option.

Note: The documentation is supplied electronically in the respective option code language. Language options are mutually exclusive, but can be combined with option D76 as a second documentation language. An additional CD-ROM with documentation in English as second documentation language will be issued. To get printed documentation in English, select option D15.



Option	Description
D02	Circuit diagrams, terminal diagrams and dimension drawings in DXF format (English only) Documents such as circuit diagrams, terminal diagrams, the arrangement diagram and the dimension drawing can be ordered with order code D02 in DXF format, e.g. for use in AutoCAD systems.
D15	One set of printed documentation If documentation is also required on paper, this must be ordered using order code D15. Multiple quantities are possible.
D00	Documentation in German
D54	Documentation in Czech
D55	Documentation In Polish
D56	Documentation in Russian
D57	Documentation in Japanese
D62	Documentation in Danish
D71	Documentation in Romanian
D72	Documentation in Italian
D73	Documentation in Finnish
D74	Documentation in Dutch
D75	Documentation In Turkish
D76	Documentation in English
D77	Documentation in French
D78	Documentation in Spanish
D79	Documentation in Portuguese (Brazil)
D80	Documentation in Bulgarian
D81	Documentation in Norwegian
D82	Documentation in Hungarian
D83	Documentation in Swedish
D84	Documentation in Chinese
D85	Documentation in Slovenian
D86	Documentation In Greek
D87	Documentation in Slovakian
D88	Documentation in Estonian
D89	Documentation in Latvian
D90	Documentation in Lithuanian

Production Schedules

The options B43 to B45 provide production schedule documents. These are sent via e-mail as PDF file in English after order clarification.

Option	Description
B43	Production schedule: one issue
B44	Production schedule: updated at 2-week intervals
B45	Production schedule: updated once per month
B49	Manufacturer data book

Customer approval drawings

Siemens offers several levels of customer drawings depending on customer needs and requirements. The approval ranges from simple interface drawing approval to complex full drawing approval from the customer. Details of approval would vary by product line and location, please, contact your Siemens sales partner for more details.

Option	Description
P30	Full release to manufacturing
P31	I/O interface approval Drawing showing customer I/O interface points will be provided for approval. All other material will be released to manufacturing.
P33	Full drawing approval All customer drawings (general arrangement / outlines and schematics) will be provided for approval. Additional engineering documents (preliminary factory acceptance test, system operating description, component data sheets / checklists, preliminary harmonic analysis, and preliminary operation manuals) will be provided at the request of the customer. All material will be held from manufacturing until full approval is received from customer.

Option	Description
--------	-------------

Y05	<p>Customer-specific nameplate</p> <p>As standard the nameplate shows the rated data of the drive under nominal conditions.</p> <p>If data on the nameplate should be adapted to special ambient conditions (temperature, altitude) or should reflect special load conditions (e.g. derating because of operation at low frequency) the option Y05 must be selected.</p> <p>Information to be supplied:</p> <ul style="list-style-type: none"> • Altitude • Coolant temperature • Rated voltages • Rated current • Rated power
Y10	<p>Circuit diagrams with customer-specific description field</p> <p>The circuit diagrams are given customer-specific headers. The data for the header must be specified in plain text (up to three lines of 45 characters per line).</p>
Y15	<p>Output filter</p> <p>The filter is typically required when cable lengths at the drive output exceed 2.3 km (7500 ft). At such long distances, the effective switching frequency harmonics and sidebands may excite a cable resonance resulting in transmission line overvoltages at the motor terminals.</p> <p>This option may also be used to address EMI or dV/dt requirements. The filter effectively removes all frequency components above 2000 Hz in the drive output voltage. Because SINAMICS PERFECT HARMONY GH180 is already free of low-order output harmonics, the result is a nearly perfect sinusoidal output waveform.</p> <p>Depending on the drive configuration, the filter may be located in transition cabinets. The filter components are dimensioned based on the continuous current rating of the power cells and maximum drive voltage.</p> <p>For more detailed information, please contact your Siemens sales partner.</p>
Y36	<p>Customer-specific cabinet labels</p> <p>Labels with customer-specific information are attached to the drive cabinets according to Siemens standard. The text and quantity of these labels need to be specified as plain text. As standard, the labels will be manufactured out of Formica, using black letters on a white background.</p>

Options Requiring Customer Specific Input

Output voltage

Option	Description
V01 ¹⁾	2.3 kV Motor Voltage
V02 ¹⁾	2.4 kV Motor Voltage
V03 ¹⁾	3.0 kV Motor Voltage
V04	3.3 kV Motor Voltage
V05	4.0 kV Motor Voltage
V06	4.16 kV Motor Voltage
V07	4.8 kV Motor Voltage
V08	5.0 kV Motor Voltage
V09	5.5 kV Motor Voltage
V10	6.0 kV Motor Voltage
V11	6.3 kV Motor Voltage
V12	6.6 kV Motor Voltage
V13	6.9 kV Motor Voltage
V14	7.2 kV Motor Voltage
V15	8.0 kV Motor Voltage
V18	10.0 kV Motor Voltage
V19	11.0 kV Motor Voltage
V26	9.8 kV Motor Voltage

1) Only available for air-cooled drives

Extension of liability for defects on drives

Siemens provides customer with the option of extending existing liability for defect periods beyond the standard ones. The liability for defect period listed in our standard terms and conditions is 12 months. The USA factory offers 24 months as a standard. Details and conditions will vary by location. This can be extended as follows:

Option	Description
Q78	3 months extension to a total of 15 months from delivery (only for drives manufactured in China)
Q79	6 months extension to a total of 18 months from delivery (only for drives manufactured in China)
Q80	12 months extension to a total of 24 months from delivery
Q81	18 months extension to a total of 30 months from delivery
Q82	24 months extension to a total of 36 months from delivery
Q83	30 months extension to a total of 42 months from delivery
Q84	36 months extension to a total of 48 months from delivery
Q85	48 months extension to a total of 60 months from delivery

Customer acceptance tests

Siemens performs rigorous factory acceptance test on all drives. Additional testing both witnessed and un-witnessed are available, please contact your Siemens sales partner for any questions or inquiries. Below is the example of some of the test available:

Option	Description
F03	Visual acceptance of the drive Open doors/panels; inspection of drive before shipping
F73	Functional acceptance of the drive with inductive load Visual acceptance; functional test with inductive load, cooling system test. Option F73 includes option F03 (visual acceptance).
F77	Acceptance test of the insulation of the drive The following is included in the scope of the acceptance tests: – High-voltage test – The insulation resistance is measured
F79	Interface check with customer equipment (5 hours, on request) For details, please contact your Siemens sales partner.
F97	Customer-specific acceptance For details, please contact your Siemens sales partner.

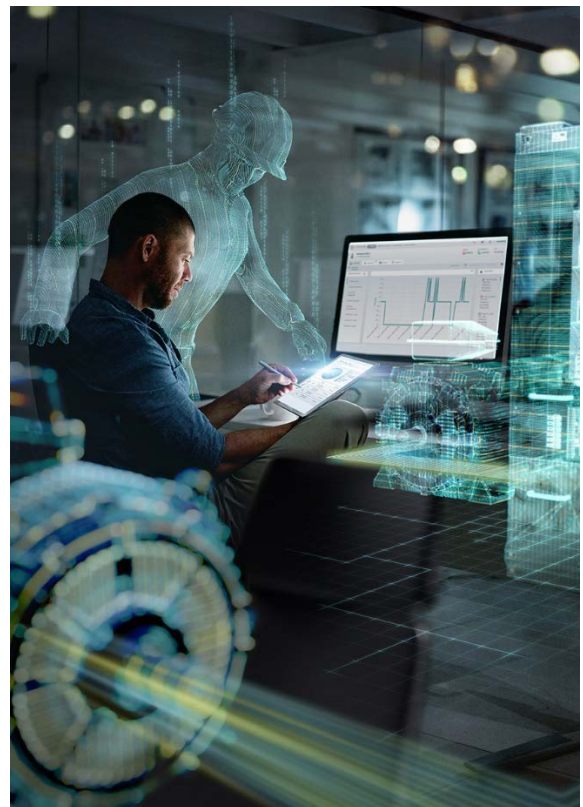

Witness tests

Witness test set up will vary by customer and factory location. Below is an example of witness test offered at our USA factory. For details contact your Siemens sales partner. Witness tests may include:

- A copy of the factory acceptance test plan for each attendee. Final certified copies of this data are published approximately two weeks after all testing is completed and shipment has occurred.
- Required PPE (Non-Prescription Safety Glasses with Side shields, Arc Flash retardant clothing, and hearing protection available upon request).
- Customer must provide their own EH rated safety shoes as required per Siemens Safety

Option	Description
F02	<p>Class 1 witness test</p> <p>Witnessed testing of a VFD will consist of tests that are part of the Siemens standard factory acceptance test defined herein for two attendees.</p> <p>Defined witnessed tests include visual inspection and operational overview.</p> <p>Operational test includes the following:</p> <ul style="list-style-type: none"> • Input protection fault simulation • Precharge sequence and fault check • Motor space heater control (if purchased) • Blower cycling • Loss of flow protection (WC) • Local/Remote control • Emergency Stop local/remote • Motor Logic • Customer control interface (excludes customer supplied equipment) • Thermal sensors • Cell bypass operation (if purchased) • Spinning load • VFD run (unloaded)
F94	<p>Class 2 witness test</p> <p>Witnessed testing of a VFD will consist of tests that are part of the Siemens standard standard factory acceptance test defined herein for five attendees</p> <p>In addition to the test mentioned in Class 1, witness test class 2 offers:</p> <ul style="list-style-type: none"> • Up to 1-hour VFD current run on a dyno motor or load reactor at 60 Hz
F95	<p>Class 3 witness test</p> <p>Witnessed testing of a VFD will consist of tests that are part of the Siemens standard factory acceptance test defined herein for up to ten attendees.</p> <p>In addition to the test mentioned in Class 1 and 2, witness test class 3 offers:</p> <ul style="list-style-type: none"> • Efficiency, power factor and harmonics tests demonstrated at defined points on a loaded VFD

Water-cooled specific options

Option	Description
E00	<p>Motor static exciter furnished by Customer</p> <p>For synchronous motor applications the static exciter cabinet will be provided by Customer independent of the drive lineup.</p>
E01	<p>Motor static exciter furnished by Siemens</p> <p>For synchronous motor applications the static exciter cabinet will be provided by Siemens as part of the drive lineup with the same degree of protection as the drive.</p>
Note:	Please contact your Siemens sales partner for technical requirements when controlling synchronous motors.

Option	Description
G89	<p>Digital relay contactor control of external auxiliaries</p> <p>This option provides the ability to control the external motor space heaters via digital relay contact. When the motor is not energized the drive activates the space heaters to maintain motor internal air temperature above the dewpoint during shutdown.</p>
Note:	This option requires an additional cabinet.

Option	Description
L33	<p>Regenerative braking</p> <p>For the applications that require intermittent regenerative operation for controlled or quick stop, the drive is equipped with regenerative cells to support this option.</p>
Note:	Available for 880 A and 1250 A. This option does not support continued operation.

Option	Description
N02	<p>Interface with customer circuit breaker – DC rated dry contacts</p> <p>These contacts are used for the drive trip signal and the close signal.</p> <p>These relays are rated at: 125 V DC, 20 A</p> <p>Minimum: 12 V DC 1 A</p>
N03	<p>Interface with customer circuit breaker – AC rated dry contacts</p> <p>These contacts are used for the drive trip signal and the close signal.</p> <p>These relays are rated at:</p> <p>240 VAC 25 A, 277 V AC 20 A and 600 V AC 10 A</p> <p>Minimum: 12 V AC 1 A.</p>
Note:	Option N02 is a default setting.

Option	Description
M88	<p>Premium corrosion protection</p> <p>The water-cooled drive is by design a self-contained configuration, so it is less affected by environmental contamination compared to an air-cooled solution. If the environment requires additional corrosion protection above the standard, the drive incorporates upgraded finishes & hardware to reduce the effects of this environment on the drive components. These additional measures include:</p> <ul style="list-style-type: none"> • Premium anti-corrosion cabinet paint capable of withstanding a maximum salt spray resistance of 5000 hours • Coated printed circuit boards • Plated bus • External stainless steel hardware • Stainless steel gland plates <p>Note: Option M88 is only available for water-cooled drives.</p>

Option	Description
P40	<p>Transformer assembly lift points outside on cabinet roof</p> <p>External lift points for overseas transportation are added to reduce potential for damage during overseas ship transportation.</p>

Option	Description
W03	<p>Bottom entry of coolant piping</p> <p>When option W32 is selected, the customer-provided coolant piping is to enter from the top of the advanced cooling cabinet (option W32). With Option W03, the coolant piping is modified to allow the customer-provided coolant piping to enter from the bottom of the advanced cooling cabinet.</p> <p>Note: Option W03 requires that option W32 (advanced cooling cabinet) is simultaneously ordered.</p>
W05	<p>Cooling cabinet high capacity expansion tank</p> <p>A drive in a system with a total volume between 250 to 500 U.S. gallons requires one high capacity coolant expansion tank.</p>

Option	Description
W32	<p>Drive prepared for liquid-to-air heat exchanger (includes advanced cooling cabinet)</p> <p>Compared to the standard cooling cabinet, this option provides customer additional features and sensors:</p> <ul style="list-style-type: none"> • Advanced control • Additional sensors • Monitoring of expansion tank level of 4 to 20 mA sensors – the signal level is available via PLC communication • PLC for monitoring / control • Dual auxiliary voltage feed available for easy installation • Dual deionizer tanks, active & spare, in separate section at front of cabinet • VFD driven pumps • Built in lift system (hoist) for changing pumps • Drive can be combined with an external liquid-to-air heat exchanger. Control of the external liquid-to-air heat exchanger: up to 12 external heat exchanger fans cycled in pairs (multi-stage cycling) <p>In addition, the deionized water cooling circuit is designed for the use of a glycol mixture up to a percentage of 60 % glycol. The amount of glycol will depend on the freezing point of the respective plant site. No current derating is required.</p> <p>Note: This advanced cooling cabinet is 60" (1522 mm) wide; it will add 23" (584 mm) to the drive length (incl. additional control box).</p>
W35	<p>Liquid-to-air heat exchanger control panel mounted on outside of the cooling cabinet</p>
W51	<p>Mechanical two-way inlet water temperature regulating valve</p> <p>With option W51 Mechanical on/off valve is supplied. A mechanical on/off valve is recommended when cooling water is supplied from well or tap.</p>
W52	<p>Mechanical three-way inlet water temperature regulating valve</p> <p>With option W52, a mechanical three-way valve is supplied. A three-way valve is recommended in the following cases:</p> <ul style="list-style-type: none"> • A constant flow is available. • Water is supplied directly from river or lake. • One cooling system for both drive and motor. <p>Note: Option W51 is a default setting.</p>

Option	Description
W55	<p>Prepared for inlet water filter for low-quality water</p> <p>With option W55, an inlet water filter is supplied. The filter protects liquid-to-liquid heat exchanger from clogging and fouling. It prevents blockages in the cooling water system by removing debris and marine life. The filter is automatically backflushed at regular intervals to keep it clean.</p> <p>Automatic flushing is carried out at regular intervals without interrupting the filtering process. This filter reduces the need for redundant liquid-to-liquid heat exchanger.</p>

Note: It is a drop ship option. Unit will be installed by the customer upstream of the heat exchanger and outside of the drive.



Example of installation with W32 option (advanced cooling cabinet): There are two water-cooled drives in the building

Option	Description
W71	<p>Deionized water provided by Siemens</p> <p>Siemens will provide the required amount of deionized water for the inner closed loop cooling system.</p>
W72	<p>Propylene glycol provided by Siemens</p> <p>Siemens will provide the required amount of glycol for the inner closed-loop cooling system.</p>

Article number structure

	1	2	3	4	5	6	7	-	8	9	10	11	12	-	13	14	15	16
SINAMICS PERFECT HARMONY GH180	6	S	R	•	•	•	•		•	■	•	•	•		•	■	■	0
4th digit: generation number																		
Generation 3				3														
Generation 4				4														
Generation 5				5														
5th digit: manufacturing location																		
Nuremberg, Germany					1													
Pittsburgh, PA, USA					2													
Shanghai, China					5													
Jundiai, Brazil					6													
6th digit: cooling method																		
Air-cooled						0												
Water-cooled						7												
7th digit: line-side behavior																		
Diode Front End (2Q)							2											
Regenerative braking (4Q, WC only)							3											
6-step regen (4Q)							4											
8th digit: rated max. output voltage																		
4.16 kV 3 AC, 9 cells								0										
5.3 kV 3 AC, 12 cells								1										
6.9 kV 3 AC, 15 cells								2										
8.0 kV 3 AC, 18 cells								3										
11.0 kV 3 AC, 24 cells								5										
2.4 kV 3 AC, 9 cells								6										
9th digit: line voltage																		
3 AC 2400 V										A								
3 AC 3000 V										B								
3 AC 3300 V										C								
3 AC 4160 V										D								
3 AC 4800 V										E								
3 AC 6000 V										F								
3 AC 6300 V										G								
3 AC 6600 V										H								
3 AC 6900 V										J								
3 AC 7200 V										K								
3 AC 8400 V										L								
3 AC 10000 V										M								
3 AC 11000 V										N								
3 AC 12000 V										P								
3 AC 12470 V										Q								
3 AC 13200 V										R								
3 AC 13800 V										S								
460 V 3 AC ¹⁾										T								
575 V 3 AC ¹⁾										U								

1) Utilization voltages, system voltages are 480 V or 600 V

	1	2	3	4	5	6	7	-	8	9	10	11	12	-	13	14	15	16	
SINAMICS PERFECT HARMONY GH180	6	S	R	•	•	•	•		•	■	•	•	•		•	■	■	0	
10th digit: Cell rating AC (2Q)																			
40 A cell												A							
70 A cell												B							
100 A cell												C							
140 A cell												D							
200 A cell												E							
260 A cell												F							
340 A cell												G							
430 A cell												H							
550 A cell												J							
600 A cell												K							
720/750 A cell												L							
Cell rating AC 6-step regen (4Q)																			
120 A cell												D							
160 A cell												E							
325 A cell												G							
Cell rating WC																			
880 A cell (regenerative braking only)												B							
1000 A cell												D							
1250 A cell (regenerative braking only)												C							
1375 A cell												E							
Drive rating: AC - transformer primary²⁾ kVA; WC - drive power HP																			
150												3	1	5					
200												3	2	0					
300												3	3	0					
400												3	4	0					
500												3	5	0					
600												3	6	0					
700												3	7	0					
800												3	8	0					
900												3	8	7					
1000												4	1	0					
1100												4	1	1					
1250												4	1	2					
1500												4	1	5					
1750												4	1	7					
2000												4	2	0					
2250												4	2	2					
2500												4	2	5					
3000												4	3	0					
3500												4	3	5					
4000												4	4	0					
4500												4	4	5					
5000												4	5	0					
5500												4	5	5					
6000												4	6	0					
6500												4	6	5					

	1	2	3	4	5	6	7	-	8	9	10	11	12	-	13	14	15	16
SINAMICS PERFECT HARMONY GH180	6	S	R	•	•	•	•		•	■	•	•	•		•	■	■	0
7000												4	7		0			
7500												4	7		5			
8000												4	8		0			
8500												4	8		5			
9000												4	8		7			
9500												4	8		8			
10000												5	2		0			
11000												5	2		2			
12000												5	2		4			
13000												5	2		6			
14000												5	2		8			
15000												5	3		0			
16000												5	3		2			
17000												5	3		4			
18000												5	3		6			
19000												5	3		8			
20000												5	4		0			
21000												5	4		2			
22000												5	4		4			
23000												5	4		6			
24000												5	4		8			
25000												5	5		0			
26000												5	5		2			
27000												5	5		4			
28000												5	5		6			
29000												5	5		8			
30000												5	6		0			
31000												5	6		2			
32000												5	6		4			
33000												5	6		6			
34000												5	6		8			
14th digit: transformer configuration (copper, aluminum)																		
60 Hz, Cu																		A
50 Hz, Cu																		B
60 Hz, Al																		E
50 Hz, Al																		F
60 Hz, Cu, high efficiency																		L
50 Hz, Cu, high efficiency																		M
60 Hz, Cu, starting duty																		N
50 Hz, Cu, starting duty																		P
60 Hz, Al, starting duty																		Q
50 Hz, Al, starting duty																		R

	1	2	3	4	5	6	7	-	8	9	10	11	12	-	13	14	15	16
SINAMICS PERFECT HARMONY GH180	6	S	R	•	•	•	•		•	■	•	•	•		•	■	■	0
15th digit: auxiliary voltage and frequency																		
200 V / 50 Hz																		A
208 V / 50 Hz																		B
230 V / 60 Hz																		C
380 V / 50 Hz																		F
400 V / 50 Hz																		G
415 V / 50 Hz																		H
460 V / 60 Hz																		J
480 V / 60 Hz																		K
575 V / 60 Hz																		L
690 V / 50 Hz																		N
Other voltage and/or frequency combination than above																		X

2) Represents primary kVA unless option U13 (one redundant cell per phase) is selected

Technical data

General technical data

General technical data		
Drive quadrants	2 or 4	
Isolation	Fiber optic cable	
Rated Efficiency 2Q drives	Typical 96 to 97 % at full rated power ¹⁾	
Rated Efficiency 4Q drives	Typical 95 to 96 % at full rated power ¹⁾	
Regulation compliances	IEEE, ANSI, NEMA, UL, CSA, CE	
Cooling	6SR5 series	6SR327 series
	Air-cooled	Water-cooled
Degree of protection	NEMA 1/ IP42 (standard)	NEMA 12/ IP54 (standard)
Altitude	Ft (m)	0 to 3,300 (1,000) standard, up to 14,763 (4,500) with derating

1) Refer to drive data sheet (see Siemens Product Configurator, page 84) and/or sales proposal for specific system efficiency.

Sound pressure level at 3 ft (1 m) 2Q drives ¹⁾		6SR5 40...70 A	6SR5 100...140 A	6SR5 200...260 A	6SR5 340...430 A	6SR5 550...750 A	6SR327 880...1375 A
9 cell (1A, 2A, 3A, 4A, 5A frames)	dB	75	80	82	80	82	76
12 cell (2B, 3B, 4B, 5B frames)	dB	80	80	80	82	82	76
15 cell (2B, 3B, 4B, 5B frames)	dB	80	80	80	82	82	76
18 cell (5C frame)	dB	–	–	–	–	82	76
24 cell (2D, 3D, 4D, 5D frames)	dB	82	82	82	82	85	76
4Q drives ¹⁾		6SR5 120...160 A	6SR5 325 A				
9 cell (3A, 4A frames)	dB	82	82				
15 cell (3B, 4B frames)	dB	80	82				
24 cell (3D, 4D frames)	dB	82	82				

1) For frame sizes see section "Air-cooled technical data" from page 54.

Power cabling cross sections ¹⁾	Frame ²⁾	6SR5 1A	6SR5 2A	6SR5 3A	6SR5 4A	6SR5 2B, 3B	6SR5 4B	6SR5 2D, 3D	6SR5 4D	6SR5 5A...5D	6SR327 –
Line-side, max. connectable per phase with M10 (M08 for 40-70A) screw z	AWG/ MCM	1 x 350 1 x 500 ³⁾	1 x 350 1 x 500 ³⁾	2 x 350 1 x 500 ³⁾	2 x 350	2 x 350	2 x 500	2 x 350	4 x 500	4 x 350	2 x 1000
	mm ²	1 x 185 1 x 240 ³⁾	1 x 185 1 x 240 ³⁾	2 x 185 1 x 240 ³⁾	2 x 185	2 x 185	2 x 240	2 x 185	4 x 240	4 x 185	2 x 500
Motor-side, max. connectable per phase with M10 (M08 for 40-70A) screw	AWG/ MCM	1 x #2	1 x 2/0	1 x 4/0	2 x 350	2 x 350	2 x 350	1 x 500	1 x 500	3 x 350	2 x 1000
	mm ²	1 x 35	1 x 75	1 x 95	2 x 185	2 x 185	2 x 185	1 x 240	1 x 240	3 x 185	2 x 500
PE, max. connec- tion cross-section at enclosure with M12 screw preliminary	AWG/ MCM	2/0	2/0	2/0	2/0	2/0	2/0	2/0	2/0	2 x 350	2 x 1000
	mm ²	75	75	75	75	75	75	75	75	2 x 185	2 x 500

1) Maximum installable size per phase, shielded cables

2) For frame sizes see section "Air-cooled technical data" from page 54.

3) Input voltage 13.8 kV

Auxiliary supply

2Q drives

Configuration		Auxiliary voltage				
		Three phase			Single phase	
		380 V	460 V	575 V	120 V	220 V
6SR5 9 cell 40-70A K79 ¹⁾	A	2.0	2.5	2.0	4.0	2.0
6SR5 9 cell 40-70A K69 ²⁾	A	3.5	4.0	3.0	–	–
6SR5 9 cell 100-140A K79 ¹⁾	A	3.5	4.0	3.5	4.0	2.0
6SR5 9 cell 100-140A K69 ²⁾	A	5.0	5.5	4.5	–	–
6SR5 9 cell 200-260A K79 ¹⁾	A	6.5	8.0	6.5	4.0	2.0
6SR5 9 cell 200-260A K69 ²⁾	A	8.0	9.5	7.5	–	–
6SR5 9 cell 340-430A K79 ¹⁾	A	10.0	11.5	9.5	4.0	2.0
6SR5 9 cell 340-430A K69 ²⁾	A	11.5	12.5	10.5	–	–
6SR5 9 cell 550A K68/K79 ¹⁾	A	16.0	13.0	9.2	7	3.5
6SR5 9 cell 550A K69 ²⁾	A	18.2	14.8	10.7	–	–
6SR5 9 cell 600A K68/K79 ¹⁾	A	16.0	15.7	11.8	7	3.5
6SR5 9 cell 600A K69 ²⁾	A	18.2	17.5	13.2	–	–
6SR5 9 cell 720A K68/K79 ¹⁾	A	18.2	15.7	11.8	7	3.5
6SR5 9 cell 720A K69 ²⁾	A	20.4	17.5	13.2	–	–
6SR5 12/15 cell 340-430A K68/ K79 ¹⁾	A	16.5	15.0	12.0	4.0	2.0
6SR5 12/15 cell 340-430A K69 ²⁾	A	17.5	16.0	13.0	–	–
6SR5 12/15 cell 550A K68/K79 ¹⁾	A	26.7	21.7	15.4	7	3.5
6SR5 12/15 cell 550A K69 ²⁾	A	28.9	23.5	16.8	–	–
6SR5 12/15 cell 600A K68/K79 ¹⁾	A	26.7	27.1	20.5	7	3.5
6SR5 12/15 cell 600A K69 ²⁾	A	28.9	28.9	21.9	–	–
6SR5 12/15 cell 750A K68/K79 ¹⁾	A	31.0	27.1	20.5	7	3.5
6SR5 12/15 cell 750A K69 ²⁾	A	33.2	28.9	21.9	–	–
6SR5 18 cell 550A K68/K79 ¹⁾	A	32.0	26.1	18.5	7	3.5
6SR5 18 cell 550A K69 ²⁾	A	34.2	27.8	19.9	–	–
6SR5 18 cell 600A K68/K79 ¹⁾	A	32.0	31.5	23.6	7	3.5
6SR5 18 cell 600A K69 ²⁾	A	34.2	33.2	25.0	–	–
6SR5 18 cell 750A K68/K79 ¹⁾	A	36.3	31.5	23.6	7	3.5
6SR5 18 cell 750A K69 ²⁾	A	38.5	33.2	25.0	–	–
6SR5 24 cell 40-70A K68 ¹⁾	A	11.0	12.4	–	–	3.5
6SR5 24 cell 40-70A K69 ²⁾	A	13.0	14.4	–	–	3.5
6SR5 24 cell 100-140A K68 ¹⁾	A	16.4	19.6	–	–	3.5
6SR5 24 cell 100-140A K69 ²⁾	A	18.4	21.6	–	–	3.5
6SR5 24 cell 200-260A K68 ¹⁾	A	27.8	34.2	–	–	3.5
6SR5 24 cell 200-260A K69 ²⁾	A	29.8	36.2	–	–	3.5
6SR5 24 cell 550A K68/K79 ¹⁾	A	37.3	30.4	21.6	7	3.5
6SR5 24 cell 550A K69 ²⁾	A	39.5	32.2	23.0	–	–
6SR5 24 cell 600A K68/K79 ¹⁾	A	37.3	38.5	29.2	7	3.5
6SR5 24 cell 600A K69 ²⁾	A	39.5	40.3	30.6	–	–
6SR5 24 cell 750A K68/K79 ¹⁾	A	43.8	38.5	29.2	7	3.5
6SR5 24 cell 750A K69 ²⁾	A	46.0	40.3	30.6	–	–

1) Single phase for NXG control

2) K69 includes CPT: control power transformer

Note: Temporary overcurrent needed for 30 s during precharge for units with 550/600/750 A or 4Q cells; please contact your Siemens sales partner for more details.

Values include cooling blowers; largest unit shown.

Option L55 (anti-condensation heating for cabinet) requires separate source.

Configuration		Auxiliary voltage				
		Three phase			Single phase	
		380 V	460 V	575 V	120 V	220 V
6SR327 K69 ¹⁾	A	1.6	1.3	1.1	–	–
6SR327 K69 ¹⁾ and W32 ³⁾	A	3.2	2.6	2.2	–	–
6SR327 9 cell 880-1375A K79 ²⁾	A	13.4	8.4	6.8	5.0	–
6SR327 9 cell 880-1375A K79 ²⁾ and W32 ³⁾	A	33.1	27.2	21.4	10.0	–
6SR327 12 cell 880-1375A K79 ²⁾	A	14.6	12.7	10.1	–	–
6SR327 12 cell 880-1375A K79 ²⁾ and W32 ³⁾	A	34.3	28.4	22.3	10.0	–
6SR327 15 cell 880-1375A K79 ²⁾	A	19.4	16.9	13.5	–	–
6SR327 15 cell 880-1375A K79 ²⁾ and W32 ³⁾	A	35.5	29.6	23.3	10.0	–
6SR327 18 cell 880-1375A K79 ²⁾	A	20.6	18.1	14.5	–	–
6SR327 18 cell 880-1375A K79 ²⁾ and W32 ³⁾	A	36.7	30.8	24.3	10.0	–
6SR327 24 cell 880-1375A K79 ²⁾	A	30.4	26.5	21.2	5.0	–
6SR327 24 cell 880-1375A K79 ²⁾ and W32 ³⁾	A	39.1	33.2	26.2	10.0	–
System pre-charge ⁴⁾	%	0.5	0.5	0.5	–	–

1) K69 includes CPT: control power transformer

2) Single phase for NXG control and 120 V AC internal heat exchanger in water-cooled systems

3) Includes cooling pumps; largest unit shown

4) Percentage of transformer kVA

Note: Options A30, A82, A83, and E04 will require slightly more current from the 120 V source.

If either the option cabinet or the exciter cabinet (E01) are present, an additional 2.1 A will be required per cabinet.

4Q drives

Configuration		Auxiliary voltage				
		Three phase			Single phase	
		380 V	460 V	575 V	120 V	220 V
6SR5 9 cell 120-160A K79 ¹⁾	A	6.5	8.0	6.5	4.0	–
6SR5 9 cell 120-160A K69 ²⁾	A	8.0	9.5	7.5	–	–
6SR5 9 cell 325A K79 ¹⁾	A	10.0	11.5	9.5	4.0	–
6SR5 9 cell 325A K69 ²⁾	A	11.5	12.5	10.5	–	–
6SR5 12/15 cell 120-160A K79 ¹⁾	A	10.0	11.5	9.5	4.0	–
6SR5 12/15 cell 120-160A K69 ²⁾	A	11.5	12.5	10.5	–	–
6SR5 12/15 cell 325A K79 ¹⁾	A	18	14	11.5	4.0	–
6SR5 12/15 cell 325A K69 ²⁾	A	22	17	14.5	–	–
6SR5 24 cell 120-160A K68 ¹⁾	A	27.8	34.2	–	–	3.5
6SR5 24 cell 120-160A K69 ²⁾	A	29.8	36.2	–	–	3.5
6SR5 24 cell 325A K68 ¹⁾	A	23.1	28.3	–	–	3.5
6SR5 24 cell 325A K69 ²⁾	A	25.1	30.3	–	–	3.5

1) Single phase for NXG control

2) K69 includes CPT: control power transformer

Note: Temporary overcurrent needed for 30 s during precharge; please contact your Siemens sales partner for more details.

Values include cooling blowers; largest unit shown.

Option L55 (anti-condensation heating for cabinet) requires separate source.

Cell overload capability

2Q Drives	6SR5												6SR327			
Cell rating [A]	40	70	100	140	200	260	340	430	550	600	720 ¹⁾	750 ²⁾	880	1000	1250	1375
110 % overload [A] (1min/10min)	40	70	100	140	200	260	340	430	550	600	655	682	880	909	1250	1250
150 % overload [A] (1min/10min)	29	51	73	103	147	191	249	315	403	440	480	500	667	667	917	917

1) 720 A for 9 cell configurations

2) 750 A for 12 through 24 cell configurations

4Q Drives	6SR5		
Cell rating [A]	120	160	325
110 % overload [A] (1min/10min)	120	160	325
150 % overload [A] (1min/10min)	88	117	238

Storage, transportation and operation data

		Storage	Transport	Operation
Climatic environmental conditions				
Ambient temperature	°C	+5 to +40 ¹⁾	-25 to +60 ¹⁾	+5 to +40 ²⁾ +5 to +50 ³⁾ -45 to +45
Outdoor Type 4				
Relative air humidity		< 95 % (only slight condensation permitted; drive must be completely dry before commissioning)	< 95 % (only slight condensation permitted; drive must be completely dry before commissioning)	< 95 % (condensation not permitted)
Other climatic conditions in accordance with class		1K3, 1Z2 in acc. with IEC 60721-3-1 ⁵⁾	2K2 in acc. with IEC 60721-3-2 ⁶⁾	3K3 in acc. with IEC 60721-3-3 ⁷⁾
Degree of pollution		2 without significant conductive or corrosive dust/gases in acc. with IEC 61800-5-1	2 without significant conductive or corrosive dust/gases in acc. with IEC 61800-5-1	2 without significant conductive or corrosive dust/gases in acc. with IEC 61800-5-1
Mechanical environmental conditions				
Stationary vibration, sinusoidal				
• Displacement	mm	1.5 (2 to 9 Hz)	3.5 (2 to 9 Hz)	0.3 (2 to 9 Hz)
• Acceleration	m/s m/s	5 (9 to 200 Hz)	10 (9 to 200 Hz) 15 (200 to 500 Hz)	1 (9 to 200 Hz)
Other mechanical conditions in accordance with class		1M2 in acc. with IEC 60721-3-1 ⁵⁾	2M2 in acc. with IEC 60721-3-2 ⁴⁾	3M1 in acc. with IEC 60721-3-3 ⁷⁾
Other environmental conditions				
Biological ambient conditions in accordance with class		1B1 in acc. with IEC 60721-3-1 ⁵⁾	2B1 in acc. with IEC 60721-3-2 ⁶⁾	3B1 in acc. with IEC 60721-3-3 ⁷⁾
Chemical active substances in accordance with class		1C1 in acc. with IEC 60721-3-1 ⁵⁾	2C1 in acc. with IEC 60721-3-2 ⁶⁾	3C1 in acc. with IEC 60721-3-3 ^{7) 8)}
Mechanical active substances in accordance with class		1S1 in acc. with IEC 60721-3-1 ⁵⁾	2S1 in acc. with IEC 60721-3-2 ⁶⁾	3S1 in acc. with IEC 60721-3-3 ^{7) 9)}

1) For water-cooled drives: no cooling water in system

2) For water-cooled drive: maximum 40 °C drive ambient air temperature with maximum 47 °C drive inlet water temperature

3) 50 °C is available with current derating for air-cooled drives; water-cooled drives – maximum 50 °C drive ambient air temperature with maximum 40 °C drive inlet water temperature

4) Siemens equipment meets all 2M2 conditions except free fall and pitch and roll.

5) IEC 60721-3-1; amendment 2, 1987 - 1993

6) IEC 60721-3-2; second edition, 1997/3

7) IEC 60721-3-3; second edition, 1994/12

8) Accumulation of dust, dirt or debris is not permitted. Drives must be installed in a controlled environment and properly maintained according to the Operating Instructions.

9) With optional NEMA 12/IP54 LV enclosures for water-cooled drives

Air-cooled technical data

2Q drives, 6SR5 40 to 750 A

2.3 kV motor voltage, 9 cell configuration (2Q)

Drive series	Shaft output ¹⁾		Motor current ¹⁾	Cell rating	Dimensions ²⁾ WxHxD		Frame	Weight ²⁾	
	Hp	kW	A		in	mm		lb	kg
6SR5.020.A315..0	150	112	34	40	48.0x102.0x40.0	1219x2591x1016	1A ³⁾	3300	1497
6SR5.020.B320..0	200	149	45	70				3700	1679
6SR5.020.B330..0	300	224	67	100				4100	1860
6SR5.020.C340..0	400	298	91	140	60.0x110.0x42.0	1524x2794x1067	2A	4400	1996
6SR5.020.D350..0	500	372	112	140				4700	2132
6SR5.020.D360..0	600	450	136	200				5100	2313
6SR5.020.E370..0	700	522	155	200	75.0x110.0x45.0	1905x2794x1143	3A	5800	2631
6SR5.020.E380..0	800	597	177					6100	2767
6SR5.020.E387..0	900	671	199					260	6700
6SR5.020.F410..0	1000	746	221	260	133.9x115.6x47.3	3400x2936x1200	4A	6800	3130
6SR5.020.F411..0	1100	820	246					7300	3312
6SR5.020.G412..0	1250	932	276					340	11377
6SR5.020.G415..0	1500	1120	331	430	133.9x115.6x47.3	3400x2936x1200	4A	11877	5388
6SR5.020.H417..0	1750	1304	386	550				12375	5614
6SR5.020.J420..0	2000	1491	442	550				228.4x114.9x53.9	5800x2916x1370
6SR5.020.J422..0	2250	1679	497		18804	8547			
6SR5.020.K425..0	2500	1865	552		600	19369	8804		
6SR5.020.L427..0	2750	2052	607	720	228.4x114.9x53.9	5800x2916x1370	5A	19932	9060
6SR5.020.L430..0	3000	2238	662					20496	9316
6SR5.020.L432..0	3250	2425	717					21624	9829

2.4 kV motor voltage, 9 cell configuration (2Q)

Drive series	Shaft output ¹⁾		Motor current ¹⁾	Cell rating	Dimensions ²⁾ WxHxD		Frame	Weight ²⁾	
	Hp	kW	A		in	mm		lb	kg
6SR5.020.A315..0	150	112	32	40	48.0x102.0x40.0	1219x2591x1016	1A ³⁾	3300	1497
6SR5.020.B320..0	200	149	43	70				3700	1679
6SR5.020.B330..0	300	224	65	100				4100	1860
6SR5.020.C340..0	400	298	87	140	60.0x110.0x42.0	1524x2794x1067	2A	4400	1996
6SR5.020.D350..0	500	373	108	140				4700	2132
6SR5.020.D360..0	600	448	130	200				5100	2313
6SR5.020.D370..0	700	522	148	200	75.0x110.0x45.0	1905x2794x1143	3A	5800	2631
6SR5.020.E380..0	800	597	169					6100	2767
6SR5.020.E387..0	900	671	190					260	6700
6SR5.020.F410..0	1000	746	212	260	133.9x115.6x47.3	3400x2936x1200	4A	6800	3130
6SR5.020.F411..0	1100	821	233					7300	3312
6SR5.020.G412..0	1250	932	264					340	11377
6SR5.020.G415..0	1500	1118	317	430	133.9x115.6x47.3	3400x2936x1200	4A	11877	5399
6SR5.020.H417..0	1750	1306	370	550				12375	5614
6SR5.020.H420..0	2000	1492	423	720				12877	5841
6SR5.020.J422..0	2250	1679	476	550	228.4x114.9x53.9	5800x2916x1370	5A	18804	8547
6SR5.020.J425..0	2500	1865	529					19369	8804
6SR5.020.K427..0	2750	2051	582					600	19932
6SR5.020.L430..0	3000	2238	635	720	228.4x114.9x53.9	5800x2916x1370	5A	20496	9316
6SR5.020.L432..0	3250	2425	688					21624	9829

- 1) The typical motor current and the power data are approximate values only; these have been calculated for operation with induction motors and for typical power factor $\cos \phi$ of 88 % and motor efficiency of 94.0 % if motor current ≤ 140 A or 96.4 % if motor current > 140 A.
- 2) Height includes blower cage; 40 to 70 A frame 1A configuration blowers are part of a cabinet, other configurations blowers are removed for shipping. Certain options might change drive dimensions and weights. Depth does not include door components, key interlocks or handles.
- 3) Frame 1A not available from China, units are built in frame 2A.

3.0 kV motor voltage, 9 cell configuration (2Q)

Drive series	Shaft output ¹⁾		Motor current ¹⁾	Cell rating	Dimensions ²⁾		Frame	Weight ²⁾	
	Hp	kW			in	mm		lb	kg
6SR5.020.A315..0	150	112	26	40	48.0x102.0x40.0	1219x2591x1016	1A ³⁾	3300	1497
6SR5.020.A320..0	200	149	34					3700	1679
6SR5.020.B330..0	300	224	51	70				4100	1860
6SR5.020.B340..0	400	298	69					4400	1996
6SR5.020.C350..0	500	372	86	100	60.0x110.0x42.0	1524x2794x1067	2A	5100	2313
6SR5.020.D360..0	600	448	103	140				5500	2495
6SR5.020.D370..0	700	521	120					5800	2631
6SR5.020.D380..0	800	597	139					6100	2767
6SR5.020.E387..0	900	671	156	200	75.0x110.0x45.0	1905x2794x1143	3A	6400	2903
6SR5.020.E410..0	1000	746	169					6800	3130
6SR5.020.E411..0	1100	820	189					260	7300
6SR5.020.F412..0	1250	932	214	8100					3674
6SR5.020.F415..0	1500	1120	254	340	133.9x115.6x47.3	3400x2936x1200	4A	9300	4218
6SR5.020.G417..0	1750	1306	296					12377	5613
6SR5.020.G420..0	2000	1491	338	430				12877	5841
6SR5.020.H422..0	2250	1679	381					13377	6068
6SR5.020.H425..0	2500	1865	423	550	228.4x114.9x53.9	5800x2916x1370	5A	14377	6522
6SR5.020.J427..0	2750	2051	465					19932	9060
6SR5.020.J430..0	3000	2240	508					20496	9316
6SR5.020.J432..0	3250	2425	550	600				21624	9829
6SR5.020.K435..0	3500	2611	592		22187	10085			
6SR5.020.L437..0	3750	2798	635	720	228.4x114.9x53.9	5800x2916x1370	5A	22751	10341
6SR5.020.L440..0	4000	2984	677					23417	10644
6SR5.020.L442..0	4250	3171	719					24082	10946

3.3 kV motor voltage, 9 cell configuration (2Q)

Drive series	Shaft output ¹⁾		Motor current ¹⁾	Cell rating	Dimensions ²⁾		Frame	Weight ²⁾	
	Hp	kW			in	mm		lb	kg
6SR5.020.A315..0	150	112	24	40	48.0x102.0x40.0	1219x2591x1016	1A ³⁾	3300	1497
6SR5.020.A320..0	200	149	31					3700	1679
6SR5.020.B330..0	300	224	47	70				4100	1860
6SR5.020.B340..0	400	298	63					4400	1996
6SR5.020.C350..0	500	373	78	100	60.0x110.0x42.0	1524x2794x1067	2A	5100	2313
6SR5.020.C360..0	600	448	94	140				5500	2495
6SR5.020.D370..0	700	522	109					5800	2631
6SR5.020.D380..0	800	597	125					6100	2767
6SR5.020.E387..0	900	671	141	200	75.0x110.0x45.0	1905x2794x1143	3A	6400	2903
6SR5.020.E410..0	1000	746	154					6800	3130
6SR5.020.E412..0	1250	932	192					260	8100
6SR5.020.F415..0	1500	1118	231	9300					4218
6SR5.020.G417..0	1750	1306	269	340	133.9x115.6x47.3	3400x2936x1200	4A	12377	5613
6SR5.020.G420..0	2000	1492	308					12877	5841
6SR5.020.H422..0	2250	1679	346	430				13377	6068
6SR5.020.H425..0	2500	1865	385					14377	6521
6SR5.020.H427..0	2750	2051	423		14877	6748			
6SR5.020.J430..0	3000	2240	462	550	228.4x114.9x53.9	5800x2916x1370	5A	20496	9316
6SR5.020.J432..0	3250	2425	500					21624	9829
6SR5.020.J435..0	3500	2611	538					600	22187
6SR5.020.K437..0	3750	2798	577	22751					10341
6SR5.020.L440..0	4000	2984	615	720	228.4x114.9x53.9	5800x2916x1370	5A	23417	10644
6SR5.020.L442..0	4250	3171	654					24082	10946
6SR5.020.L445..0	4500	3356	692					24748	11249

- 1) The typical motor current and the power data are approximate values only; these have been calculated for operation with induction motors and for typical power factor $\cos \phi$ of 88 % and motor efficiency of 94.0 % if motor current ≤ 140 A or 96.4 % if motor current > 140 A.
- 2) Height includes blower cage; 40 to 70 A frame 1A configuration blowers are part of a cabinet, other configurations blowers are removed for shipping. Certain options might change drive dimensions and weights. Depth does not include door components, key interlocks or handles.
- 3) Frame 1A not available from China, units are built in frame 2A.

4.0 kV motor voltage, 9 cell configuration (2Q)

Drive series	Shaft output ¹⁾		Motor current ¹⁾	Cell rating A	Dimensions ²⁾ WxHxD		Frame	Weight ²⁾	
	Hp	kW	A		in	mm		lb	kg
6SR5.020.A315..0	150	112	19	40	48.0x102.0x40.0	1219x2591x1016	1A ³⁾	3300	1497
6SR5.020.A320..0	200	149	26					3700	1679
6SR5.020.A330..0	300	224	39					4100	1860
6SR5.020.B340..0	400	298	51	70				4400	1996
6SR5.020.B350..0	500	372	64					4700	2132
6SR5.020.C360..0	600	448	77	100				5500	2495
6SR5.020.C370..0	700	521	90					5800	2631
6SR5.020.D380..0	800	597	103	140	60.0x110.0x42.0	1524x2794x1067	2A	6100	2767
6SR5.020.D387..0	900	671	116					6400	2903
6SR5.020.D410..0	1000	746	129					6500	2949
6SR5.020.E411..0	1100	820	143	200	75.0x110.0x45.0	1905x2794x1143	3A	7300	3312
6SR5.020.E412..0	1250	932	161					8100	3675
6SR5.020.E415..0	1500	1120	190					9300	4219
6SR5.020.F417..0	1750	1304	222	260				10500	4763
6SR5.020.F420..0	2000	1491	254					11800	5353
6SR5.020.G422..0	2250	1679	286	340				13377	6068
6SR5.020.G425..0	2500	1865	317					14377	6521
6SR5.020.H427..0	2750	2051	349	430	133.9x115.6x47.3	3400x2936x1200	4A	14877	6748
6SR5.020.H430..0	3000	2240	381					15377	6975
6SR5.020.H432..0	3250	2425	413					15877	7202
6SR5.020.J435..0	3500	2611	444	550				22187	10085
6SR5.020.J437..0	3750	2798	476					22751	10341
6SR5.020.J440..0	4000	2984	508					23417	10644
6SR5.020.J442..0	4250	3171	539					24082	10946
6SR5.020.K445..0	4500	3356	571	600	228.4x114.9x53.9	5800x2916x1370	5A	24748	11249
6SR5.020.L447..0	4750	3544	603					25413	11551
6SR5.020.L450..0	5000	3730	635	720				26057	11844
6SR5.020.L452..0	5250	3917	665					26057	11844
6SR5.020.L455..0	5500	4103	698					26700	12136

- 1) The typical motor current and the power data are approximate values only; these have been calculated for operation with induction motors and for typical power factor $\cos \phi$ of 88 % and motor efficiency of 94.0 % if motor current ≤ 140 A or 96.4 % if motor current > 140 A.
- 2) Height includes blower cage; 40 to 70 A frame 1A configuration blowers are part of a cabinet, other configurations blowers are removed for shipping. Certain options might change drive dimensions and weights. Depth does not include door components, key interlocks or handles.
- 3) Frame 1A not available from China, units are built in frame 2A.

4.16 kV motor voltage, 9 cell configuration (2Q)

Drive series	Shaft output ¹⁾		Motor current ¹⁾	Cell rating A	Dimensions ²⁾ WxHxD		Frame	Weight ²⁾	
	Hp	kW	A		in	mm		lb	kg
6SR5.020.A315..0	150	112	19	40	48.0x102.0x40.0	1219x2591x1016	1A ³⁾	3300	1497
6SR5.020.A320..0	200	149	26					3700	1678
6SR5.020.A330..0	300	224	38					4100	1860
6SR5.020.B340..0	400	298	50	70	48.0x102.0x40.0	1219x2591x1016	1A ³⁾	4400	1996
6SR5.020.B350..0	500	373	63					4700	2132
6SR5.020.C360..0	600	448	75	100	60.0x110.0x42.0	1524x2794x1067	2A	5500	2495
6SR5.020.C370..0	700	522	88					5800	2631
6SR5.020.C380..0	800	597	100					6100	2767
6SR5.020.D387..0	900	671	113	140	60.0x110.0x42.0	1524x2794x1067	2A	6400	2903
6SR5.020.D410..0	1000	746	125					6500	2948
6SR5.020.D411..0	1100	821	138					7300	3312
6SR5.020.E412..0	1250	933	153	200	75.0x110.0x45.0	1905x2794x1143	3A	8100	3674
6SR5.020.E415..0	1500	1119	183					9300	4218
6SR5.020.F417..0	1750	1306	214	260	75.0x110.0x45.0	1905x2794x1143	3A	10500	4763
6SR5.020.F420..0	2000	1492	244					11800	5352
6SR5.020.G422..0	2250	1679	275	340	133.9x115.6x47.3	3400x2936x1200	4A	13377	6068
6SR5.020.G425..0	2500	1865	305					14377	6521
6SR5.020.G427..0	2750	2052	336					14877	6748
6SR5.020.H430..0	3000	2238	366	430	133.9x115.6x47.3	3400x2936x1200	4A	15377	6975
6SR5.020.H432..0	3250	2425	397					15877	7202
6SR5.020.H435..0	3500	2611	427					16377	7429
6SR5.020.J440..0	4000	2984	488	550	228.4x114.9x53.9	5800x2916x1370	5A	23417	10644
6SR5.020.J442..0	4250	3171	519	24082				10946	
6SR5.020.K445..0	4500	3357	549	600				24748	11249
6SR5.020.K447..0	4750	3544	580		25413	11551			
6SR5.020.L450..0	5000	3730	610	720	228.4x114.9x53.9	5800x2916x1370	5A	26057	11844
6SR5.020.L452..0	5250	3917	641					26057	11844
6SR5.020.L455..0	5500	4103	671					26700	12136
6SR5.020.L457..0	5750	4290	702					27349	12431

- 1) The typical motor current and the power data are approximate values only; these have been calculated for operation with induction motors and for typical power factor $\cos \phi$ of 88 % and motor efficiency of 94.0 % if motor current ≤ 140 A or 96.4 % if motor current > 140 A.
- 2) Height includes blower cage; 40 to 70 A frame 1A configuration blowers are part of a cabinet, other configurations blowers are removed for shipping. Certain options might change drive dimensions and weights. Depth does not include door components, key interlocks or handles.
- 3) Frame 1A not available from China, units are built in frame 2A.

4.8 kV motor voltage, 12 cell configuration (2Q)

Drive series	Shaft output ¹⁾		Motor current ¹⁾	Cell rating	Dimensions ²⁾ WxHxD		Frame	Weight ²⁾							
	Hp	kW	A	A	in	mm		lb	kg						
6SR5.021.A330..0	300	224	33	40	114.2x115.6x42.0	2900x2936x1065	2B	5390	2450						
6SR5.021.B340..0	400	298	43	70				5740	2610						
6SR5.021.B350..0	500	373	54					6070	2760						
6SR5.021.B360..0	600	448	65					6400	2910						
6SR5.021.C370..0	700	522	76	100				114.2x115.6x42.0	2900x2936x1065	2B	6730	3060			
6SR5.021.C380..0	800	597	87								7060	3210			
6SR5.021.C387..0	900	671	98								7390	3360			
6SR5.021.D410..0	1000	746	108	140							114.2x115.6x42.0	2900x2936x1065	2B	7740	3520
6SR5.021.D412..0	1250	933	136		8580	3900									
6SR5.021.E415..0	1500	1119	159	200	133.9x115.6x47.3	3400x2936x1200	3B							10890	4950
6SR5.021.E417..0	1750	1306	185											11460	5210
6SR5.021.F420..0	2000	1492	212	260										133.9x115.6x47.3	3400x2936x1200
6SR5.021.F422..0	2250	1679	238					12610	5730						
6SR5.021.G425..0	2500	1865	264	340	218.8x114.9x52.1	5550x2916x1323	4B	17854	8115						
6SR5.021.G427..0	2750	2052	291					18116	8234						
6SR5.021.G430..0	3000	2238	317					430	18366	8348					
6SR5.021.H432..0	3250	2435	344	18897					8589						
6SR5.021.H435..0	3500	2611	370	430				218.8x114.9x52.1	5550x2916x1323	4B	19497	8862			
6SR5.021.H440..0	4000	2984	423								18886	8580			
6SR5.021.J442..0	4250	3171	450								550	266.2x114.9x53.9	6759x2916x1370	5B	27129
6SR5.021.J445..0	4500	3356	476	27794											12633
6SR5.021.J447..0	4750	3544	502	600	28460	12936									
6SR5.021.J450..0	5000	3730	529		29125	13238									
6SR5.021.K452..0	5250	3917	555	600	266.2x114.9x53.9	6759x2916x1370	5B				29769				13531
6SR5.021.K455..0	5500	4103	582								30412				13823
6SR5.021.L457..0	5750	4290	608					750	31054	14115					
6SR5.021.L460..0	6000	4476	635	31699					14408						
6SR5.021.L465..0	6500	4847	688	750					33074	15033					
6SR5.021.L470..0	7000	5222	740						278.0x128.2x53.9	7059x3256x1370	34103	15501			

- 1) The typical motor current and the power data are approximate values only; these have been calculated for operation with induction motors and for typical power factor cos φ of 88 % and motor efficiency of 94.0 % if motor current ≤ 140 A or 96.4 % if motor current > 140 A.
- 2) Height includes blower cage; blowers are removed for shipping. Certain options might change drive dimensions and weights. Depth does not include door components, key interlocks or handles.

6.0 kV motor voltage, 15 cell configuration (2Q)

Drive series	Shaft output ¹⁾		Motor current ¹⁾	Cell rating	Dimensions ²⁾ WxHxD		Frame	Weight ²⁾				
	Hp	kW	A		in	mm		lb	kg			
6SR5.022.A330..0	300	224	26	40	114.2x115.6x42.0	2900x2936x1065	2B	5540	2513			
6SR5.022.A340..0	400	298	34					5900	2677			
6SR5.022.B350..0	500	372	43	70				6230	2826			
6SR5.022.B360..0	600	450	51					6560	2976			
6SR5.022.B370..0	700	521	60					6890	3126			
6SR5.022.B380..0	800	600	69					7220	3275			
6SR5.022.C387..0	900	671	77	100				7550	3425			
6SR5.022.C410..0	1000	746	86					7900	3584			
6SR5.022.D412..0	1250	932	107	140				8730	3960			
6SR5.022.D415..0	1500	1120	129					9550	4332			
6SR5.022.E417..0	1750	1304	150	200	133.9x115.6x47.3	3400x2936x1200	3B	11750	5330			
6SR5.022.E420..0	2000	1491	169					12320	5589			
6SR5.022.E422..0	2250	1677	190					12890	5847			
6SR5.022.F425..0	2500	1865	212					260	13460	6106		
6SR5.022.F427..0	2750	2051	233						14060	6378		
6SR5.022.F430..0	3000	2240	260						14630	6637		
6SR5.022.G432..0	3250	2425	278	340	218.8x114.9x52.1	5550x2916x1323	4B	19497	8844			
6SR5.022.G435..0	3500	2497	300					20097	9116			
6SR5.022.H440..0	4000	2982	343	430				21226	9628			
6SR5.022.H445..0	4500	3356	386					22560	10234			
6SR5.022.H450..0	5000	3728	428					23894	10839			
6SR5.022.J452..0	5250	3917	444	550				266.2x114.9x53.9	6759x2916x1370	5B	28373	12897
6SR5.022.J455..0	5500	4101	465								29038	13199
6SR5.022.J457..0	5750	4290	487								29704	13502
6SR5.022.J460..0	6000	4474	508								32943	14974
6SR5.022.K465..0	6500	4847	550	600							34071	15487
6SR5.022.K470..0	7000	5219	592		34584	15720						
6SR5.022.L475..0	7500	5595	635	750	278.0x128.2x53.9	7059x3256x1370	5B				34797	15817
6SR5.022.L480..0	8000	5968	677								35187	15994
6SR5.022.L485..0	8500	6341	719					35682	16219			

1) The typical motor current and the power data are approximate values only; these have been calculated for operation with induction motors and for typical power factor cos φ of 88 % and motor efficiency of 94.0 % if motor current ≤ 140 A or 96.4 % if motor current > 140 A.

2) Height includes blower cage; blowers are removed for shipping. Certain options might change drive dimensions and weights. Depth does not include door components, key interlocks or handles.

6.6 kV motor voltage, 15 cell configuration (2Q)

Drive series	Shaft output ¹⁾		Motor current ¹⁾	Cell rating	Dimensions ²⁾ WxHxD		Frame	Weight ²⁾																																									
	Hp	kW	A		A	in		mm	lb	kg																																							
6SR5.022.A330..0	300	223	24	40	114.2x115.6x42.0	2900x2936x1065	2B	5540	2520																																								
6SR5.022.A340..0	400	298	31					5900	2680																																								
6SR5.022.A350..0	500	372	39					6230	2830																																								
6SR5.022.B360..0	600	450	47	70				114.2x115.6x42.0	2900x2936x1065	2B	6560	2980																																					
6SR5.022.B370..0	700	521	55								6890	3130																																					
6SR5.022.B380..0	800	600	62								7220	3280																																					
6SR5.022.C387..0	900	671	70	100							114.2x115.6x42.0	2900x2936x1065	2B	7550	3430																																		
6SR5.022.C410..0	1000	746	78											7900	3590																																		
6SR5.022.C412..0	1250	932	100											9550	4340																																		
6SR5.022.D415..0	1500	1120	117	140										114.2x115.6x42.0	2900x2936x1065	2B	10380	4720																															
6SR5.022.D417..0	1750	1304	138														11750	5340																															
6SR5.022.E420..0	2000	1492	154														200	133.9x115.6x47.3	3400x2936x1200	3B	12320	5600																											
6SR5.022.E422..0	2250	1679	173	12890																	5860																												
6SR5.022.E425..0	2500	1865	192	260																	133.9x115.6x47.3	3400x2936x1200	3B	13460	6120																								
6SR5.022.F427..0	2750	2051	212														14060							6390																									
6SR5.022.F430..0	3000	2238	231		14630	6650																																											
6SR5.022.G435..0	3500	2600	296	340	218.8x114.9x52.1	5550x2916x1323	4B										20097							9135																									
6SR5.022.G440..0	4000	2982	312														430							218.8x114.9x52.1	5550x2916x1323	4B	25452	11569																					
6SR5.022.H445..0	4500	3356	351					550	218.8x114.9x52.1	5550x2916x1323																	4B	26580	12082																				
6SR5.022.H450..0	5000	3728	389	750																								218.8x114.9x52.1	5550x2916x1323	4B	27707	12594																	
6SR5.022.H455..0	5500	4101	428														550														218.8x114.9x52.1	5550x2916x1323	4B	29038	13199														
6SR5.022.J457..0	5750	4290	448					266.2x114.9x53.9			278.0x128.2x53.9	7059x3256x1370	5B																					29704	13502														
6SR5.022.J460..0	6000	4474	467	600																														278.0x128.2x53.9	7059x3256x1370	5B	32943	14974											
6SR5.022.J465..0	6500	4847	506														750																				278.0x128.2x53.9	7059x3256x1370	5B	34071	15487								
6SR5.022.J470..0	7000	5219	545					750						278.0x128.2x53.9	7059x3256x1370	5B																								34584	15720								
6SR5.022.K475..0	7500	5595	584	750																																				278.0x128.2x53.9	7059x3256x1370	5B	34797	15817					
6SR5.022.L480..0	8000	5965	623														750	278.0x128.2x53.9	7059x3256x1370	5B																							35187	15994					
6SR5.022.L485..0	8500	6341	662					750																																			278.0x128.2x53.9	7059x3256x1370	5B	35682	16219		
6SR5.022.L487..0	9000	6714	701	750																	278.0x128.2x53.9	7059x3256x1370	5B																							36177	16444		
6SR5.022.L488..0	9500	7087	699														750																													278.0x128.2x53.9	7059x3256x1370	5B	36709
6SR5.022.L520..0	10000	7460	779					750																																									278.0x128.2x53.9

- 1) The typical motor current and the power data are approximate values only; these have been calculated for operation with induction motors and for typical power factor $\cos \varphi$ of 88 % and motor efficiency of 94.0 % if motor current ≤ 140 A or 96.4 % if motor current > 140 A.
- 2) Height includes blower cage; blowers are removed for shipping. Certain options might change drive dimensions and weights. Depth does not include door components, key interlocks or handles.

6.9 kV motor voltage, 15 cell configuration (2Q)

Drive series	Shaft output ¹⁾		Motor current ¹⁾	Cell rating	Dimensions ²⁾		Frame	Weight ²⁾										
	Hp	kW	A		WxHxD			in	mm	lb	kg							
6SR5.022.A330..0	300	224	22	40	114.2x115.6x42.0	2900x2936x1065	2B	5540	2513									
6SR5.022.A340..0	400	298	30					5900	2677									
6SR5.022.A350..0	500	372	37					6230	2826									
6SR5.022.B360..0	600	450	45	70				114.2x115.6x42.0	2900x2936x1065	2B	6560	2976						
6SR5.022.B370..0	700	521	52								6890	3126						
6SR5.022.B380..0	800	600	60								7220	3275						
6SR5.022.B387..0	900	671	70	7550							3425							
6SR5.022.C410..0	1000	746	75	100							114.2x115.6x42.0	2900x2936x1065	2B	7900	3584			
6SR5.022.C412..0	1250	932	100											8730	3960			
6SR5.022.D415..0	1500	1120	112	140										114.2x115.6x42.0	2900x2936x1065	2B	9550	4332
6SR5.022.D417..0	1750	1304	130		10380	4709												
6SR5.022.E420..0	2000	1491	147	200	133.9x115.6x47.3	3400x2936x1200	3B										12320	5589
6SR5.022.E422..0	2250	1677	166														12890	5847
6SR5.022.E425..0	2500	1862	186					13460	6106									
6SR5.022.F427..0	2750	2051	202	260				133.9x115.6x47.3	3400x2936x1200	3B							14060	6378
6SR5.022.F430..0	3000	2240	221														14630	6637
6SR5.022.F435..0	3500	2611	258														15770	7170
6SR5.022.G440..0	4000	2982	294	340							218.8x114.9x52.1	5550x2916x1323	4B				21226	9628
6SR5.022.G445..0	4500	3356	331														22560	10234
6SR5.022.H450..0	5000	3730	368	430										218.8x114.9x52.1	5550x2916x1323	4B	23894	10839
6SR5.022.H455..0	5500	4101	405														25183	11423
6SR5.022.J460..0	6000	4474	442	550	266.2x114.9x53.9	6759x2916x1370	5B										32943	14974
6SR5.022.J465..0	6500	4847	478														34071	15487
6SR5.022.J470..0	7000	5219	515														34584	15720
6SR5.022.K475..0	7500	5595	552	600				266.2x114.9x53.9	6759x2916x1370	5B							34797	15817
6SR5.022.K480..0	8000	5968	589														35187	15994
6SR5.022.L485..0	8500	6341	625	750													278.0x128.2x53.9	7059x3256x1370
6SR5.022.L487..0	9000	6714	662								36177	16444						
6SR5.022.L488..0	9500	7087	699								36709	16686						
6SR5.022.L520..0	10000	7460	736								37241	16928						

- 1) The typical motor current and the power data are approximate values only; these have been calculated for operation with induction motors and for typical power factor $\cos \phi$ of 88 % and motor efficiency of 94.0 % if motor current ≤ 140 A or 96.4 % if motor current > 140 A.
- 2) Height includes blower cage; blowers are removed for shipping. Certain options might change drive dimensions and weights. Depth does not include door components, key interlocks or handles.

7.2 kV motor voltage, 18 cell configuration (2Q)

Drive series	Shaft output ¹⁾		Motor current ¹⁾	Cell rating A	Dimensions ²⁾ WxHxD		Frame	Weight ²⁾				
	Hp	kW	A		in	mm		lb	kg			
6SR5.023.J440..0	4000	2984	282	550	281.9x114.9x53.9	7159x2916x1370	5C	28435	12925			
6SR5.023.J442..0	4250	3171	300					29101	13228			
6SR5.023.J445..0	4500	3356	317					29766	13530			
6SR5.023.J447..0	4750	3544	335					30432	13833			
6SR5.023.J450..0	5000	3728	353					31097	14135			
6SR5.023.J452..0	5250	3917	370					31741	14428			
6SR5.023.J455..0	5500	4101	388					32384	14720			
6SR5.023.J457..0	5750	4290	405					32947	14976			
6SR5.023.J460..0	6000	4474	423					33510	15232			
6SR5.023.J465..0	6500	4847	458					34639	15745			
6SR5.023.J470..0	7000	5219	494					35094	15952			
6SR5.023.J475..0	7500	5595	529					35246	16021			
6SR5.023.K480..0	8000	5968	564					600	293.7x128.2x53.9	7459x3256x1370	35840	16291
6SR5.023.K485..0	8500	6341	599								36434	16561
6SR5.023.L487..0	9000	6714	635	750	37028	16831						
6SR5.023.L488..0	9500	7087	670		37622	17101						
6SR5.023.L520..0	10000	7460	705		38216	17371						
6SR5.023.L521..0	10500	7830	740		326.0x135.9x53.9	8279x3453x1370	38810				17641	

8.0 kV motor voltage, 18 cell configuration (2Q)

Drive series	Shaft output ¹⁾		Motor current ¹⁾	Cell rating A	Dimensions ²⁾ WxHxD		Frame	Weight ²⁾				
	Hp	kW	A		in	mm		lb	kg			
6SR5.023.J440..0	4000	2982	254	550	281.9x114.9x53.9	7159x2916x1370	5C	28435	12925			
6SR5.023.J442..0	4250	3171	270					29101	13228			
6SR5.023.J445..0	4500	3356	286					29766	13530			
6SR5.023.J447..0	4750	3544	301					30432	13833			
6SR5.023.J450..0	5000	3728	317					31097	14135			
6SR5.023.J452..0	5250	3917	333					31741	14428			
6SR5.023.J455..0	5500	4101	349					32384	14720			
6SR5.023.J457..0	5750	4290	365					32947	14976			
6SR5.023.J460..0	6000	4474	381					33510	15232			
6SR5.023.J465..0	6500	4847	413					34639	15745			
6SR5.023.J470..0	7000	5219	444					35094	15952			
6SR5.023.J475..0	7500	5595	476					35246	16021			
6SR5.023.J480..0	8000	5965	508					600	293.7x128.2x53.9	7459x3256x1370	35840	16291
6SR5.023.J485..0	8500	6341	539								36434	16561
6SR5.023.K487..0	9000	6714	571	37028	16831							
6SR5.023.L488..0	9500	7087	603	37622	17101							
6SR5.023.L520..0	10000	7460	635	750	326.0x135.9x53.9	8279x3453x1370	38216	17371				
6SR5.023.L521..0	10500	7833	667				38810	17641				
6SR5.023.L522..0	11000	8206	698				39404	17911				
6SR5.023.L523..0	11500	8579	730				40596	18453				

- 1) The typical motor current and the power data are approximate values only; these have been calculated for operation with induction motors and for typical power factor cos φ of 88 % and motor efficiency of 94.0 % if motor current ≤ 140 A or 96.4 % if motor current > 140 A.
- 2) Height includes blower cage; blowers are removed for shipping. Certain options might change drive dimensions and weights. Depth does not include door components, key interlocks or handles.

10.0 kV motor voltage, 24 cell configuration (2Q)

Drive series	Shaft output ¹⁾		Motor current ¹⁾	Cell rating A	Dimensions ²⁾ WxHxD		Frame	Weight ²⁾					
	Hp	kW	A		in	mm		lb	kg				
6SR55025.A330..0	300	224	16	40	93.7x117.6x63.0	2380x2988x1600	2D ³⁾	6075	2755				
6SR55025.A340..0	400	298	21					6317	2865				
6SR55025.A350..0	500	373	26					6516	2955				
6SR55025.A360..0	600	448	31					6780	3075				
6SR55025.A370..0	700	522	36					6956	3155				
6SR55025.B380..0	800	597	42					7273	3299				
6SR55025.B387..0	900	671	47	70	93.7x117.6x63.0 ³⁾	2380x2988x1600 ³⁾	2D ³⁾⁴⁾	7494	3399				
6SR55025.B410..0	1000	746	52					7648	3469				
6SR55025.B412..0	1250	933	65					8133	3689				
6SR55025.C415..0	1500	1119	78	100	93.7x117.6x63.0 ³⁾	2380x2988x1600 ³⁾	2D ³⁾⁴⁾	9004	4084				
6SR55025.C417..0	1750	1306	91					9467	4294				
6SR55025.D420..0	2000	1492	104	140	93.7x117.6x63.0 ³⁾	2380x2988x1600 ³⁾	2D ³⁾⁴⁾	9922	4500				
6SR55025.D422..0	2250	1679	117					10473	4750				
6SR55025.D425..0	2500	1865	130					10737	4870				
6SR55025.D427..0	2750	2052	140					11068	5020				
6SR55025.E430..0	3000	2238	152	200	205.7x119.7x49.2	5226x3040x1250	3D ³⁾	16002	7258				
6SR55025.E432..0	3250	2425	165					17680	8019				
6SR55025.E435..0	3500	2611	178					18187	8249				
6SR55025.E437..0	3750	2798	190					18694	8479				
6SR55025.F440..0	4000	2984	203					260	205.7x119.7x49.2	5226x3040x1250	3D ³⁾	19418	8808
6SR55025.F442..0	4250	3171	216									19936	9043
6SR55025.F445..0	4500	3357	228	20355	9233								
6SR55025.F447..0	4750	3544	241	20774	9423								
6SR55025.F450..0	5000	3730	254	21281	9653								
6SR55025.F452..0	5250	3917	260	21788	9883								
6SR5.025.G450..0	5000	3730	254	340	266.5x114.9x56.1	6767x2916x1423	4D	30703	13927				
6SR5.025.G455..0	5500	4101	279					32324	14662				
6SR5.025.G460..0	6000	4476	305					33175	5048				
6SR5.025.G465..0	6500	4849	330					34469	15635				
6SR5.025.H470..0	7000	5222	355	430	266.5x114.9x56.1	6767x2916x1423	4D	35761	16221				
6SR5.025.H475..0	7500	5595	381					37114	16835				
6SR5.025.H480..0	8000	5968	406					38204	17329				
6SR5.025.J485..0	8500	6341	432	550	331.4x128.2x53.9	8418x3256x1370	5D	40927	18603				
6SR5.025.J487..0	9000	6714	457					41526	18875				
6SR5.025.J488..0	9500	7087	482					42124	19147				
6SR5.025.J520..0	10000	7460	508					42722	19419				
6SR5.025.J521..0	10500	7830	540					43321	25678				
6SR5.025.K522..0	11000	8206	559					600	331.4x128.2x53.9	8418x3256x1370	5D	43919	25950
6SR5.025.K523..0	11500	8579	584	45116	26494								
6SR5.025.L524..0	12000	8952	609	750	363.8x136.1x53.9	9238x3453x1370	5D	45714	26766				
6SR5.025.L525..0	12500	9325	635					46735	27230				
6SR5.025.L526..0	13000	9698	660					48451	28010				
6SR5.025.L527..0	13500	10071	685					50167	28790				
6SR5.025.L528..0	14000	10444	711					51883	29570				
6SR5.025.L587..0	14500	10817	736					53599	24363				

- 1) The typical motor current and the power data are approximate values only; these have been calculated for operation with induction motors and for typical power factor $\cos \phi$ of 88 % and motor efficiency of 94.0 % if motor current ≤ 140 A or 96.4 % if motor current > 140 A.
- 2) Height includes blower cage; blowers are removed for shipping. Certain options might change drive dimensions and weights. Depth does not include door components, key interlocks or handles.
- 3) Rear access required: approx. ≥ 1000 mm / 39.4"
- 4) Height is without option M61 (redundant blower). With option M61 height will be 3088 mm (121.6 in).

11.0 kV motor voltage, 24 cell configuration (2Q)

Drive series	Shaft output ¹⁾		Motor current ¹⁾	Cell rating	Dimensions ²⁾		Frame	Weight ²⁾	
	Hp	kW	A		A	WxHxD		in	mm
6SR55025.A330..0	300	224	14	40	93.7x117.6x63.0	2380x2988x1600	2D ³⁾	6075	2755
6SR55025.A340..0	400	298	19					6317	2865
6SR55025.A350..0	500	373	24					6516	2955
6SR55025.A360..0	600	448	28					6780	3075
6SR55025.A370..0	700	560	33					6956	3155
6SR55025.A380..0	800	640	38					7199	3265
6SR55025.B387..0	900	720	43	70	93.7x117.6x63.0	2380x2988x1600	7494	3399	
6SR55025.B410..0	1000	800	47				7648	3469	
6SR55025.B412..0	1250	1000	59				8133	3689	
6SR55025.B415..0	1500	1200	70	100	93.7x117.6x63.0	2380x2988x1600	8772	3979	
6SR55025.C417..0	1750	1400	83				9467	4294	
6SR55025.C420..0	2000	1600	95	140	93.7x117.6x63.0	2380x2988x1600	9731	4414	
6SR55025.D422..0	2250	1679	107				10473	4750	
6SR55025.D425..0	2500	1865	118				10737	4870	
6SR55025.D427..0	2750	2052	130				11068	5020	
6SR55025.D430..0	3000	2238	140				11377	5160	
6SR55025.E432..0	3250	2425	154				200	205.7x119.7x49.2	5226x3040x1250
6SR55025.E435..0	3500	2611	166	18187	8249				
6SR55025.E437..0	3750	2798	178	18694	8479				
6SR55025.E440..0	4000	2984	189	19212	8714				
6SR55025.E442..0	4250	3171	201	19730	8949				
6SR55025.F445..0	4500	3357	213	20355	9233				
6SR55025.F447..0	4750	3544	225	20774	9423				
6SR55025.F450..0	5000	3730	237	21281	9653				
6SR55025.F452..0	5250	3917	249	21788	9883				
6SR55025.F455..0	5500	4103	260	22412	10166				
6SR55025.F457..0	5750	4290	260	22979	10423				
6SR5.025.G450..0	5000	3728	231	340	266.5x114.9x56.1	6767x2916x1423			
6SR5.025.G455..0	5500	4103	254				32324	14662	
6SR5.025.G460..0	6000	4476	277				33175	15048	
6SR5.025.G465..0	6500	4849	300				34469	15635	
6SR5.025.G470..0	7000	5222	323				35761	16221	
6SR5.025.H475..0	7500	5595	346				37114	16835	
6SR5.025.H480..0	8000	5968	369	430	266.5x114.9x56.1	6767x2916x1423	38204	17330	
6SR5.025.H485..0	8500	6341	392				39293	17824	
6SR5.025.H487..0	9000	6714	415				40382	18317	
6SR5.025.J488..0	9500	7087	438				42124	18875	
6SR5.025.J520..0	10000	7460	462				42722	19419	
6SR5.025.J521..0	10500	7833	485				43321	25678	
6SR5.025.J522..0	11000	8206	508	550	331.4x128.2x53.9	8418x3256x1370	43919	25950	
6SR5.025.J523..0	11500	8579	531				45116	26494	
6SR5.025.K524..0	12000	8952	554				45714	26766	
6SR5.025.K525..0	12500	9325	577				46735	27230	
6SR5.025.K526..0	13000	9698	600				48451	28010	
6SR5.025.L527..0	13500	10071	623				50167	28790	
6SR5.025.L528..0	14000	10444	646				51883	29570	
6SR5.025.L587..0	14500	10817	669				53599	24363	
6SR5.025.L530..0	15000	11190	692				55315	25143	
6SR5.025.L531..0	15500	11563	715				57031	25923	
6SR5.025.L532..0	16000	11936	739	58747	26703				

- 1) The typical motor current and the power data are approximate values only; these have been calculated for operation with induction motors and for typical power factor cos φ of 88 % and motor efficiency of 94.0 % if motor current ≤ 140 A or 96.4 % if motor current > 140 A.
- 2) Height includes blower cage; blowers are removed for shipping. Certain options might change drive dimensions and weights. Depth does not include door components, key interlocks or handles.
- 3) Rear access required: approx. ≥ 1000 mm / 39.4"
- 4) Height is without option M61 (redundant blower). With option M61 height will be 3088 mm (121.6 in).

4Q drives, 6SR5 120 to 325 A

2.3 kV motor voltage, 9 cell configuration (4Q)

Drive series	Shaft output ¹⁾		Motor current ¹⁾ A	Cell rating A	Dimensions ²⁾ WxHxD		Frame	Weight ²⁾	
	Hp	kW			in	mm		lb	kg
6SR5.040.D330..0	300	224	67	120	75.0x110.0x45.0	1905x2794x1143	3A	4144	1880
6SR5.040.D340..0	400	298	91					4560	2069
6SR5.040.D350..0	500	373	113					4976	2258
6SR5.040.E360..0	600	448	136	160				5392	2446
6SR5.040.E370..0	700	522	156					5900	2677
6SR5.040.G410..0	1000	746	221	325	133.9x115.6x47.3	3400x2936x1200	4A	10911	4948
6SR5.040.G412..0	1250	932	279					11577	5252

2.4 kV motor voltage, 9 cell configuration (4Q)

Drive series	Shaft output ¹⁾		Motor current ¹⁾ A	Cell rating A	Dimensions ²⁾ WxHxD		Frame	Weight ²⁾	
	Hp	kW			in	mm		lb	kg
6SR5.040.D330..0	300	224	64	120	75.0x110.0x45.0	1905x2794x1143	3A	4144	1880
6SR5.040.D340..0	400	298	86					4560	2069
6SR5.040.D350..0	500	373	107					4976	2258
6SR5.040.E360..0	600	448	129	160				5392	2446
6SR5.040.E370..0	700	522	150					5900	2677
6SR5.040.G412..0	1250	932	264	325	133.9x115.6x47.3	3400x2936x1200	4A	11577	5252
6SR5.040.G415..0	1500	1120	321					12077	5479

3.0 kV motor voltage, 9 cell configuration (4Q)

Drive series	Shaft output ¹⁾		Motor current ¹⁾ A	Cell rating A	Dimensions ²⁾ WxHxD		Frame	Weight ²⁾	
	Hp	kW			in	mm		lb	kg
6SR5.040.D330..0	300	224	51	120	75.0x110.0x45.0	1905x2794x1143	3A	4144	1880
6SR5.040.D340..0	400	298	69					4560	2069
6SR5.040.D350..0	500	372	86					4976	2258
6SR5.040.D360..0	600	450	103	160				5392	2446
6SR5.040.D370..0	700	521	120					5900	2677
6SR5.040.E380..0	800	600	137	160				6100	2767
6SR5.040.E387..0	900	671	154					6800	3085
6SR5.040.G412..0	1250	932	214	325	133.9x115.6x47.3	3400x2936x1200	4A	11577	5252
6SR5.040.G415..0	1500	1120	257					12077	5479
6SR5.040.G417..0	1750	1304	300					12577	5705

1) The typical motor current and the power data are approximate values only; these have been calculated for operation with induction motors and for typical power factor $\cos \phi$ of 88 % and motor efficiency of 94.0 % if motor current ≤ 140 A or 96.4 % if motor current > 140 A.

2) Height includes blower cage; blowers are removed for shipping. Certain options might change drive dimensions and weights. Depth does not include door components, key interlocks or handles.

3.3 kV motor voltage, 9 cell configuration (4Q)

Drive series	Shaft output ¹⁾		Motor current ¹⁾	Cell rating A	Dimensions ²⁾ WxHxD		Frame	Weight ²⁾	
	Hp	kW	A		in	mm		lb	kg
6SR5.040.D330..0	300	224	47	120	75.0x110.0x45.0	1905x2794x1143	3A	4144	1880
6SR5.040.D340..0	400	298	62					4560	2069
6SR5.040.D350..0	500	372	78					4976	2258
6SR5.040.D360..0	600	450	93					5392	2446
6SR5.040.D370..0	700	521	109					5900	2677
6SR5.040.E380..0	800	600	125	160	75.0x110.0x45.0	1905x2794x1143	3A	6100	2767
6SR5.040.E387..0	900	671	140					6800	3085
6SR5.040.E410..0	1000	746	156					6900	3130
6SR5.040.G412..0	1250	932	192	325	133.9x115.6x47.3	3400x2936x1200	4A	11577	5252
6SR5.040.G415..0	1500	1120	234					12077	5479
6SR5.040.G417..0	1750	1304	269					12577	5705
6SR5.040.G420..0	2000	1491	308					13077	5932

4.0 kV motor voltage, 9 cell configuration (4Q)

Drive series	Shaft output ¹⁾		Motor current ¹⁾	Cell rating A	Dimensions ²⁾ WxHxD		Frame	Weight ²⁾	
	Hp	kW	A		in	mm		lb	kg
6SR5.040.D330..0	300	224	39	120	75.0x110.0x45.0	1905x2794x1143	3A	4144	1880
6SR5.040.D340..0	400	298	51					4560	2069
6SR5.040.D350..0	500	372	64					4976	2258
6SR5.040.D360..0	600	450	78					5392	2446
6SR5.040.D370..0	700	521	90					5900	2677
6SR5.040.D380..0	800	600	103	160	75.0x110.0x45.0	1905x2794x1143	3A	6100	2767
6SR5.040.D387..0	900	671	116					6800	3085
6SR5.040.E410..0	1000	746	129					6900	3130
6SR5.040.E411..0	1100	820	141	325	133.9x115.6x47.3	3400x2936x1200	4A	7400	3357
6SR5.040.G412..0	1250	932	161					11577	5252
6SR5.040.G415..0	1500	1120	193					12077	5479
6SR5.040.G417..0	1750	1304	225					12577	5705
6SR5.040.G420..0	2000	1491	257					13077	5932
6SR5.040.G422..0	2250	1677	286	325	133.9x115.6x47.3	3400x2936x1200	4A	13577	6159
6SR5.040.G425..0	2500	1862	317					14577	6613

4.16 kV motor voltage, 9-cell configuration (4Q)

Drive series	Shaft output ¹⁾		Motor current ¹⁾	Cell rating A	Dimensions ²⁾ WxHxD		Frame	Weight ²⁾	
	Hp	kW	A		in	mm		lb	kg
6SR5.040.D330..0	300	224	37	120	75.0x110.0x45.0	1905x2794x1143	3A	4144	1880
6SR5.040.D340..0	400	298	49					4560	2069
6SR5.040.D350..0	500	372	62					4976	2258
6SR5.040.D360..0	600	450	74					5392	2446
6SR5.040.D370..0	700	521	87					5900	2677
6SR5.040.D380..0	800	600	99	160	75.0x110.0x45.0	1905x2794x1143	3A	6100	2767
6SR5.040.D387..0	900	671	111					6800	3085
6SR5.040.E410..0	1000	746	124					6900	3130
6SR5.040.E411..0	1100	820	136	325	133.9x115.6x47.3	3400x2936x1200	4A	7400	3357
6SR5.040.E412..0	1250	932	154					8200	3720
6SR5.040.G415..0	1500	1120	185					12077	5479
6SR5.040.G417..0	1750	1304	216					12577	5705
6SR5.040.G420..0	2000	1491	247					13077	5932
6SR5.040.G422..0	2250	1677	278	325	133.9x115.6x47.3	3400x2936x1200	4A	13577	6159
6SR5.040.G425..0	2500	1862	309					14577	6613

1) The typical motor current and the power data are approximate values only; these have been calculated for operation with induction motors and for typical power factor $\cos \phi$ of 88 % and motor efficiency of 94.0 % if motor current ≤ 140 A or 96.4 % if motor current > 140 A.
 2) Height includes blower cage; blowers are removed for shipping. Certain options might change drive dimensions and weights. Depth does not include door components, key interlocks or handles.

6.0 kV motor voltage, 15 cell configuration (4Q)

Drive series	Shaft output ¹⁾		Motor current ¹⁾	Cell rating	Dimensions ²⁾		Frame	Weight ²⁾	
	Hp	kW	A		WxHxD	in		mm	lb
6SR5.042.D330..0	300	224	26	120	133.9x115.6x47.3	3400x2936x1200	3B	8646	3922
6SR5.042.D340..0	400	298	34					8874	4026
6SR5.042.D350..0	500	372	43					9102	4129
6SR5.042.D360..0	600	450	51					9330	4233
6SR5.042.D370..0	700	521	60					9558	4336
6SR5.042.D380..0	800	600	69					9786	4439
6SR5.042.D387..0	900	671	77					10014	4543
6SR5.042.D410..0	1000	671	86					10242	4646
6SR5.042.D412..0	1250	932	107					10812	4905
6SR5.042.E415..0	1500	1120	129	160			11382	5163	
6SR5.042.E417..0	1750	1304	150				11952	5422	
6SR5.042.G420..0	2000	1491	171	325	218.8x114.9x52.1	5550x2916x1323	4B	17873	8108
6SR5.042.G422..0	2250	1677	193					18454	8371
6SR5.042.G425..0	2500	1862	214					19004	8621
6SR5.042.G427..0	2750	2051	236					19266	8739
6SR5.042.G430..0	3000	2240	257					19516	8853
6SR5.042.G432..0	3250	2425	278					20047	9094
6SR5.042.G435..0	3500	2611	300					20647	9366

6.6 kV motor voltage, 15 cell configuration (4Q)

Drive series	Shaft output ¹⁾		Motor current ¹⁾	Cell rating	Dimensions ²⁾		Frame	Weight ²⁾	
	Hp	kW	A		WxHxD	in		mm	lb
6SR5.042.D330..0	300	224	23	120	133.9x115.6x47.3	3400x2936x1200	3B	8646	3922
6SR5.042.D340..0	400	298	31					8874	4026
6SR5.042.D350..0	500	372	39					9102	4129
6SR5.042.D360..0	600	450	47					9330	4233
6SR5.042.D370..0	700	521	55					9558	4336
6SR5.042.D380..0	800	600	62					9786	4439
6SR5.042.D387..0	900	671	70					10014	4543
6SR5.042.D410..0	1000	746	78					10242	4646
6SR5.042.D412..0	1250	932	97					10812	4905
6SR5.042.D415..0	1500	1120	117	160			11382	5163	
6SR5.042.E417..0	1750	1304	136				11952	5422	
6SR5.042.E420..0	2000	1491	156	325	218.8x114.9x52.1	5550x2916x1323	4B	12522	5680
6SR5.042.G422..0	2250	1677	175					18454	8371
6SR5.042.G425..0	2500	1862	192					19004	8621
6SR5.042.G427..0	2750	2051	214					19266	8739
6SR5.042.G430..0	3000	2240	234					19516	8853
6SR5.042.G432..0	3250	2425	253					20047	9094
6SR5.042.G435..0	3500	2611	273					20647	9366
6SR5.042.G440..0	4000	2982	308					21776	9878

- 1) The typical motor current and the power data are approximate values only; these have been calculated for operation with induction motors and for typical power factor $\cos \phi$ of 88 % and motor efficiency of 94.0 % if motor current ≤ 140 A or 96.4 % if motor current > 140 A.
- 2) Height includes blower cage; blowers are removed for shipping. Certain options might change drive dimensions and weights. Depth does not include door components, key interlocks or handles.

10.0 kV motor voltage, 24 cell configuration (4Q)

Drive series	Shaft output ¹⁾		Motor current ¹⁾	Cell rating	Dimensions ²⁾		Frame	Weight ²⁾	
	Hp	kW	A		WxHxD	in		mm	lb
6SR55045.D350..0	500	373	25	120	205.7×119.7×49.2	5226×3040×1250	3D ³⁾	10783	4891
6SR55045.D375..0	750	560	38					11480	5207
6SR55045.D410..0	1000	746	51					12176	5523
6SR55045.D412..0	1250	933	63					12688	5755
6SR55045.D415..0	1500	1119	76					13408	6082
6SR55045.D417..0	1750	1306	89					13919	6314
6SR55045.D420..0	2000	1492	102					14329	6500
6SR55045.D422..0	2250	1679	114					14737	6685
6SR55045.E427..0	2750	2052	140	160			15930	7226	
6SR55045.E430..0	3000	2238	152				17120	7766	
6SR55045.G432..0	3250	2425	165	325	266.5×114.9×56.1	6767×2916×1423	4D	27485	12468
6SR55045.G437..0	3750	2798	190					28201	12793
6SR55045.G400..0	4000	2984	203					28675	13008
6SR55045.G442..0	4250	3171	216					29160	13228
6SR55045.G450..0	4500	3357	228					29645	13448
6SR55045.G447..0	4750	3544	241					30119	13663
6SR55045.G450..0	5000	3730	254					30813	13978
6SR55045.G452..0	5250	3917	267					31497	14288
6SR55045.G455..0	5500	4101	280					32340	14670
6SR55045.G457..0	5750	4290	292					32875	14913
6SR55045.G460..0	6000	4476	305					33569	15228

11.0 kV motor voltage, 24 cell configuration (4Q)

Drive series	Shaft output ¹⁾		Motor current ¹⁾	Cell rating	Dimensions ²⁾		Frame	Weight ²⁾	
	Hp	kW	A		WxHxD	in		mm	lb
6SR55045.D350..0	500	373	23	120	205.7×119.7×49.2	5226×3040×1250	3D ³⁾	10783	4891
6SR55045.D375..0	750	560	35					11480	5207
6SR55045.D410..0	1000	746	46					12176	5523
6SR55045.D412..0	1250	933	58					12688	5755
6SR55045.D415..0	1500	1119	69					13201	5988
6SR55045.D417..0	1750	1306	81					13919	6314
6SR55045.D420..0	2000	1492	92					14329	6500
6SR55045.D422..0	2250	1679	104					14737	6685
6SR55045.E427..0	2750	2052	127	160			15930	7226	
6SR55045.E430..0	3000	2238	138				17120	7766	
6SR55045.E432..0	3250	2425	150	325	266.5×114.9×56.1	6767×2916×1423	4D	18478	8382
6SR55045.G437..0	3750	2798	173					28201	12793
6SR55045.G400..0	4000	2984	185					28675	13008
6SR55045.G442..0	4250	3171	196					29160	13228
6SR55045.G450..0	4500	3357	208					29645	13448
6SR55045.G447..0	4750	3544	219					30119	13663
6SR55045.G450..0	5000	3730	231					30813	13978
6SR55045.G452..0	5250	3917	242					31497	14288
6SR55045.G455..0	5500	4101	250					32340	14670
6SR55045.G457..0	5750	4290	265					32875	14913
6SR55045.G460..0	6000	4476	277					33569	15228
6SR55045.G465..0	6500	4849	300					34076	15458
6SR55045.G470..0	7000	5222	323					34605	15698

- 1) The typical motor current and the power data are approximate values only; these have been calculated for operation with induction motors and for typical power factor $\cos \varphi$ of 88 % and motor efficiency of 94.0 % if motor current ≤ 140 A or 96.4 % if motor current > 140 A.
- 2) Height includes blower cage; blowers are removed for shipping. Certain options might change drive dimensions and weights. Depth does not include door components, key interlocks or handles.
- 3) Rear access required: approx. ≥ 1000 mm / 39.4"

Air-cooled dimension drawings

Drawings below represent standard SINAMICS PERFECT HARMONY G180 air-cooled drive layouts. Transformer and control section can be either part of the cell cabinet (e.g., 9 cell configurations) or located in separate cabinets (e.g., 24 cell configurations). The power and current ranges specified refer to the 2Q versions.

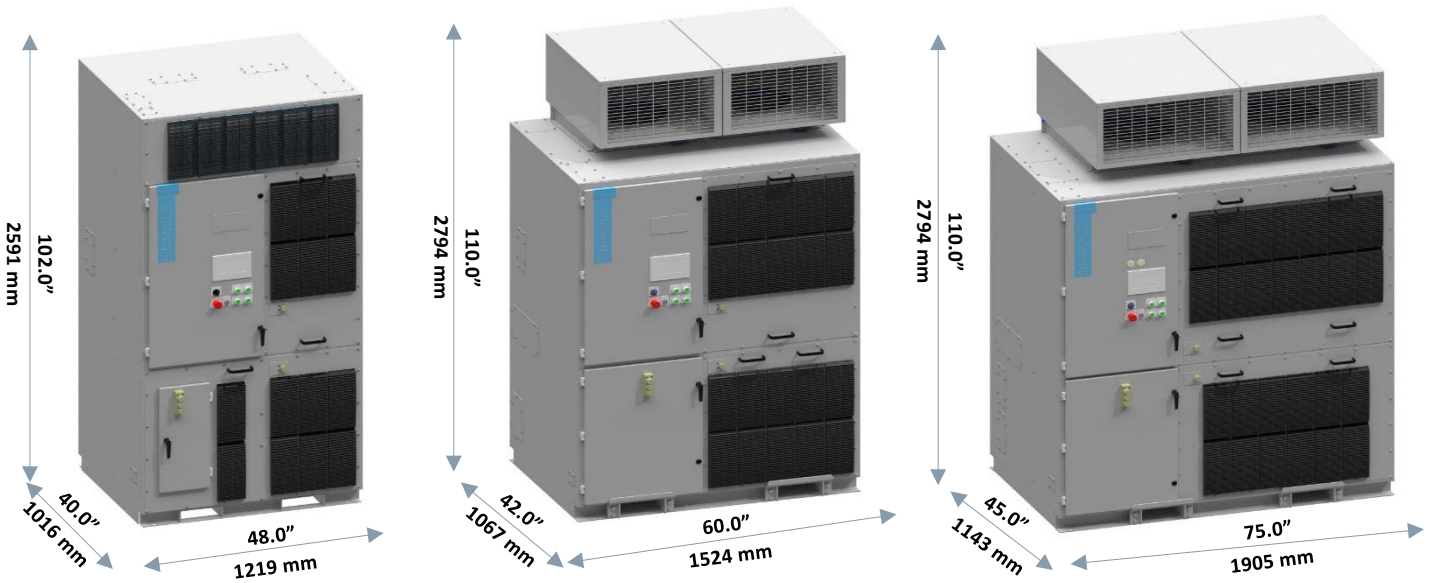

Frame 1A, 150 to 500 HP, 40/70 A
(except for drives manufactured in China)

Frame 2A, 9 cell, 400 to 1100 HP, 100/140 A
(and 40/70 A for drives manufactured in China)

Frame 3A, 9 cell, 300 to 2000 HP, 200/260 A

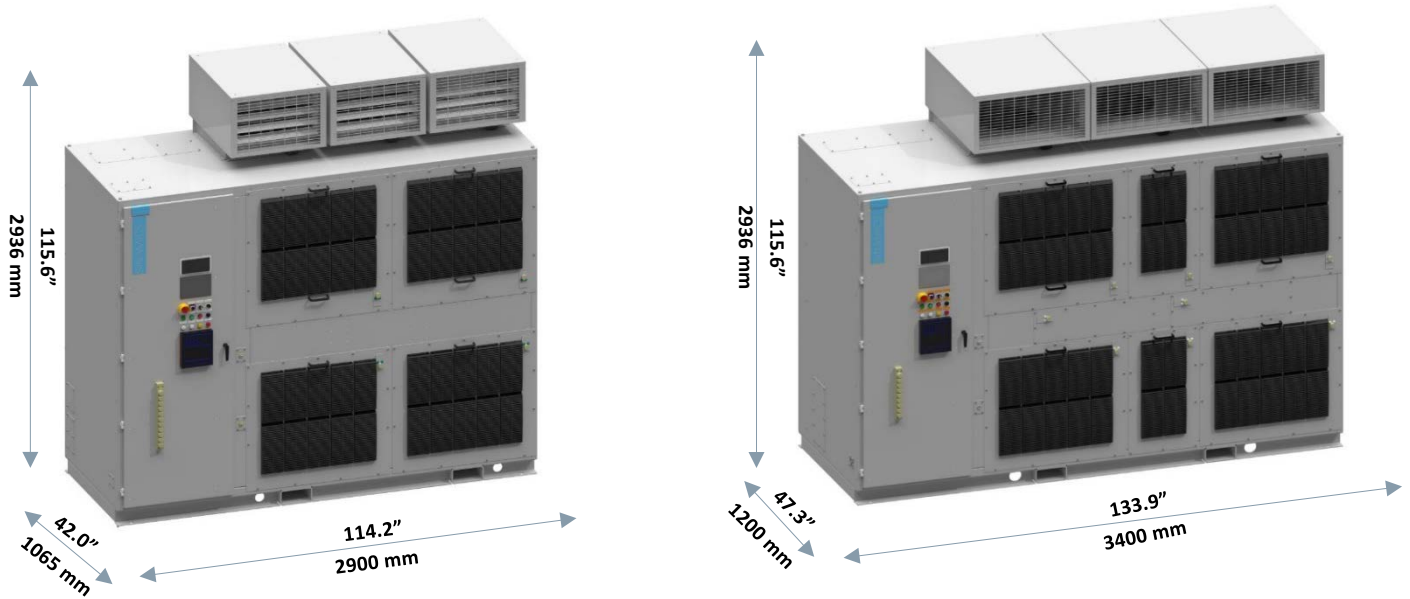

Frame 2B, 12/15 cell, 300 to 1750 HP, 40 to 140 A

Frame 3B, 12/15 cell, 1500 to 3500 HP, 200/260 A

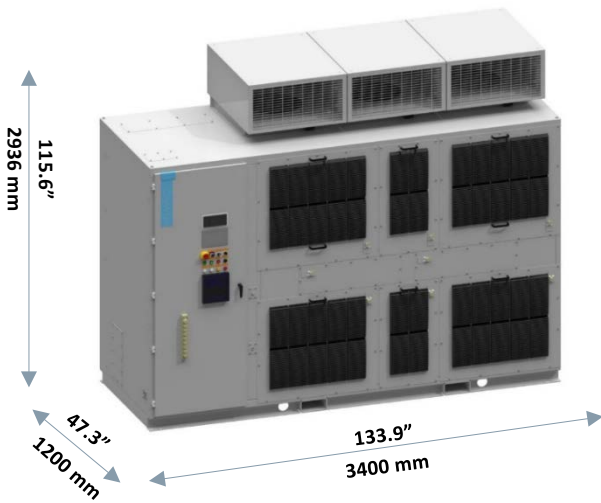

Frame 4A, 9 cell, 1250 to 3500 HP, 340/430 A

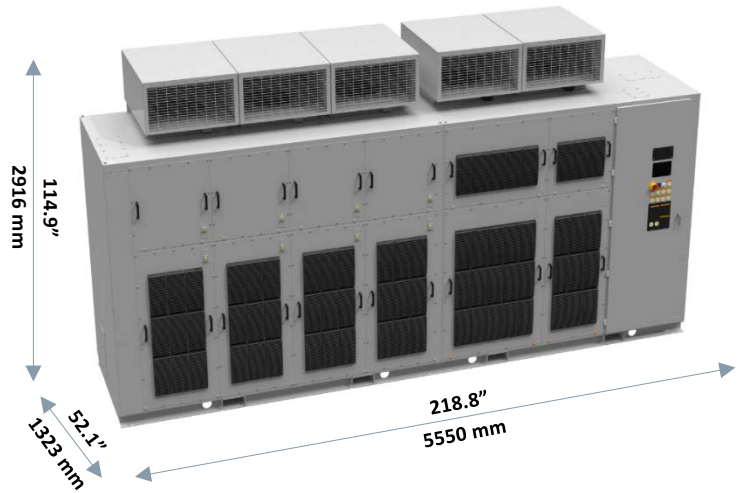

Frame 4B, 12/15 cell, 2500 to 5500 HP, 340/430 A

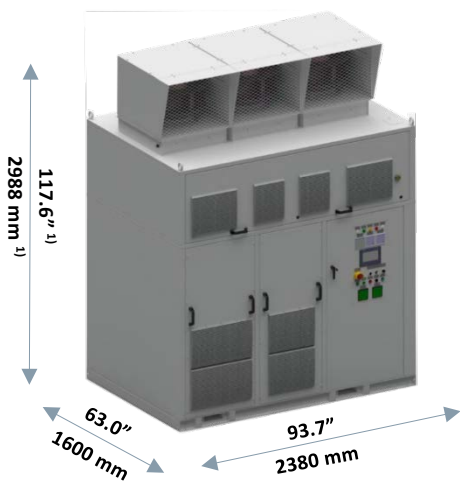

Frame 2D, 24 cell, 300 to 3000 HP, 40 to 140 A ²⁾

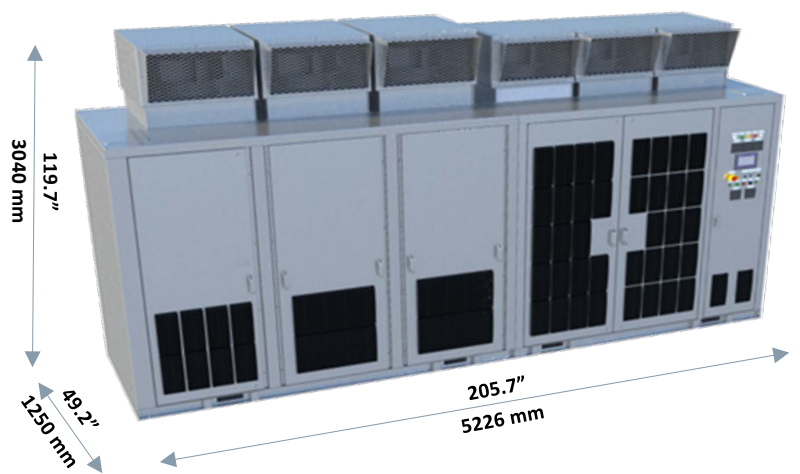

Frame 3D, 24 cell, 1750 to 5750 HP, 200/260 A ²⁾

1) Height with option M61 (redundant blower): 3088 mm / 121.6"
 2) Rear access required: approx. \geq 1000 mm / 39.4"

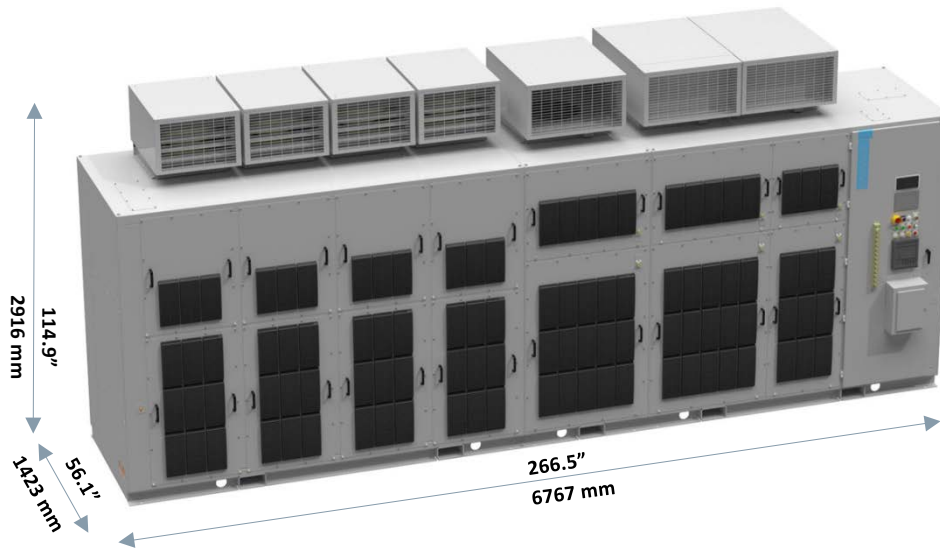

Frame 4D, 24 cell, 5000 to 9000 HP, 340/430A

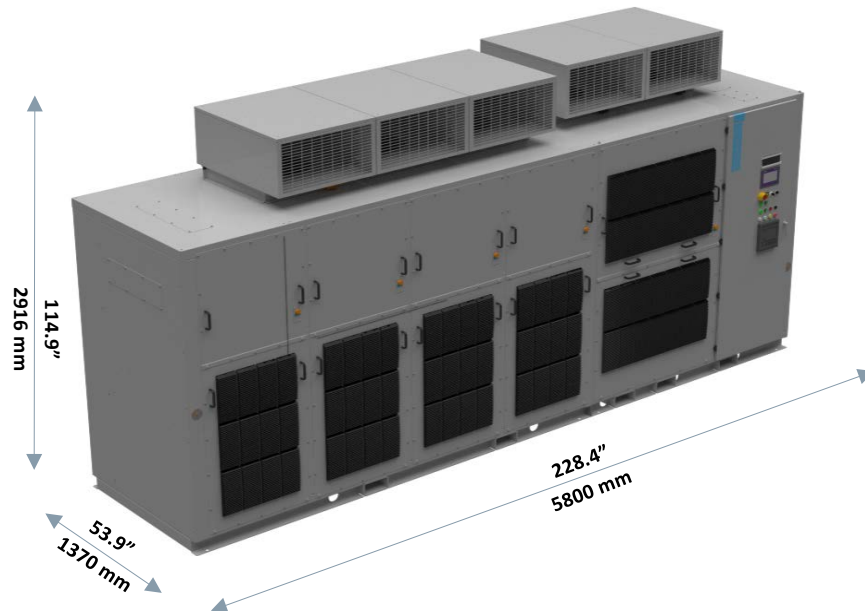

Frame 5A, 9 cell, 2000 to 5750 HP, 550/600/720 A

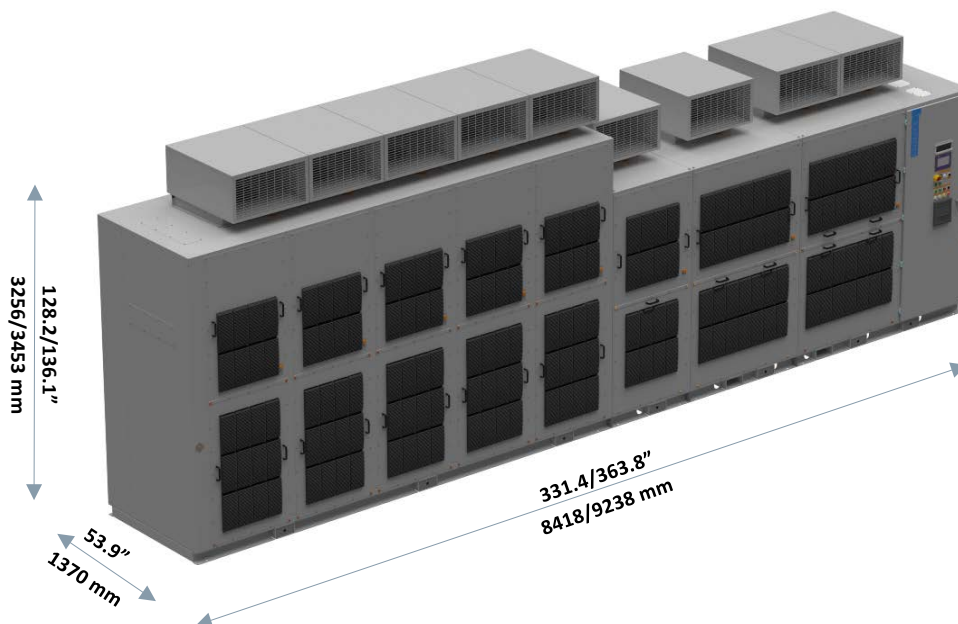

Frame 5D, 24 cell, 8500 to 16000 HP, 550/600/750 A

Air-cooled dimension drawings with options

There are options that will impact the dimensions of the SINAMICS PERFECT HARMONY GH180 air-cooled 9 cell drive as well as air-cooled 500 to 750 A configurations. The list of options for 9 cell 40 to 260 A configuration is:

- N44 Make-proof grounding switch at the drive input
- N45 Make-proof grounding switch at the drive output
- A30 Touchscreen with standard cable (HMI)
- K20 Signal lamp in the cabinet door
- K21 Display instruments for voltage, current and speed
- E04 Additional customer analog, digital inputs and outputs (I/O) modules
- L50 Cabinet lighting and service socket outlet
- L36 Input snubber
- A82 SEL 710 motor protection relay standalone option
- A83 Multilin 869 motor protection relay standalone option
- Input voltage greater than 7.2 k V:
8.4 kV to 13.8 kV input voltage
- Low voltage input 460 V for 300 HP and above
- Low voltage input 575 V for 400 HP and above

Note:

For the above, option M53 (24" option cabinet) will be required for drives manufactured in USA or option H03 (1000 mm option cabinet) for China.

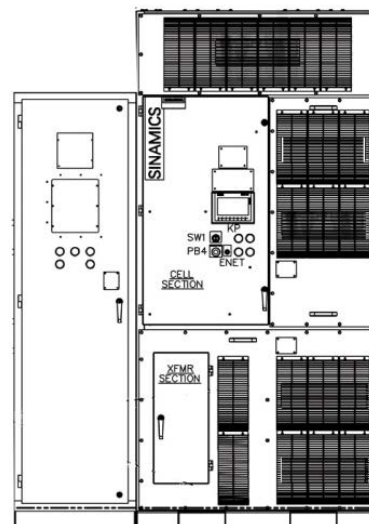

6SR5 9 cell 40 to 70 A drawing with option cabinet
(example only, 100 to 140 and 200 to 260 A cabinets will be bigger)

Water-cooled technical data

3.3 kV motor voltage, 9 cell configuration

Drive Series	Shaft Output ¹⁾		Motor Current ¹⁾	Cell Rating	Dimensions ^{2,3)} WxHxD		Weight		
	Hp	kW	A	A	in	mm	lb	kg	
6SR32720.D440..0	4000	2984	623	1000	305x115x70	7747x2921x1778	M	35659	16175
6SR32720.D450..0	5000	3730	779	1000				37920	17200
6SR32720.D460..0	6000	4476	935	1000				40869	18538
6SR32720.C465..0	6500	4849	1013	1250				40869	18538
6SR32720.C470..0	7000	5222	1091	1250				41830	18974
6SR32720.C475..0	7500	5595	1168	1250				42755	19393
6SR32720.C480..0	8000	5968	1246	1250				43649	19799
6SR32720.E485..0	8500	6341	1324	1375				43742	19841

4.16 kV motor voltage, 9 cell configuration

Drive Series	Shaft Output ¹⁾		Motor Current ¹⁾	Cell Rating	Dimensions ^{2,3)} WxHxD		Weight		
	Hp	kW	A	A	in	mm	lb	kg	
6SR32720.D440..0	4000	2984	494	1000	305x115x70	7747x2921x1778	M	35266	15996
6SR32720.D450..0	5000	3730	634	1000				37419	16973
6SR32720.D460..0	6000	4476	742	1000				39370	17858
6SR32720.D465..0	6500	4849	803	1000				39370	17858
6SR32720.D470..0	7000	5222	865	1000				40285	18273
6SR32720.D475..0	7500	5595	926	1000				42067	19081
6SR32720.D480..0	8000	5968	989	1000				42242	19161
6SR32720.C485..0	8500	6341	1050	1250				43742	19841
6SR32720.C490..0	9000	6714	1112	1250				44541	20203
6SR32720.C495..0	9500	7087	1174	1250				44541	20203
6SR32720.C520..0	10000	7460	1235	1250				45317	20555
6SR32720.E522..0	11000	8206	1359	1375				46808	21232

- 1) The typical motor current and the power data are approximate values only; these have been calculated for operation with induction motors and for typical power factor $\cos \phi$ of 88% and motor efficiency of 95.2%
- 2) Outline Drawing number
- 3) Certain options will change drive dimensions, for more details see outline page

4.8 kV motor voltage, 12 cell configuration

Drive Series	Shaft Output ¹⁾		Motor Current ¹⁾ A	Cell Rating A	Dimensions ^{2,3)} WxHxD		Weight		
	Hp	kW			in	mm	lb	kg	
6SR32721.D440..0	4000	2984	428	1000	331x115x70	8395x2921x1778	M	38647	17530
6SR32721.D450..0	5000	3730	536	1000				40823	18517
6SR32721.D460..0	6000	4476	643	1000				42793	19411
6SR32721.D465..0	6500	4849	696	1000				42793	19411
6SR32721.D470..0	7000	5222	750	1000				43718	19830
6SR32721.D475..0	7500	5595	803	1000				44608	20234
6SR32721.D480..0	8000	5968	857	1000				45468	20624
6SR32721.D485..0	8500	6341	910	1000				47500	21546
6SR32721.D487..0	9000	6714	964	1000				48307	21912
6SR32721.C488..0	9500	7087	1017	1250				48307	21912
6SR32721.C520..0	10000	7460	1071	1250				49091	22267
6SR32721.C522..0	11000	8206	1178	1250				50598	22951
6SR32721.E524..0	12000	8952	1285	1375				52032	23601

6.6/6.9 kV motor voltage, 15 cell configuration

Drive Series	Shaft Output ¹⁾		Motor Current ¹⁾ A	Cell Rating A	Dimensions ^{2,3)} WxHxD		Weight		
	Hp	kW			in	mm	lb	kg	
6SR32722.D460..0	6000	4474	468	1000	356x115x70	9043x2921x1778	M	46214	20962
6SR32722.D470..0	7000	5219	545	1000				47148	21386
6SR32722.D480..0	8000	5968	623	1000				48916	22188
6SR32722.D485..0	8500	6341	662	1000				49756	22569
6SR32722.D487..0	9000	6714	701	1000				50571	22939
6SR32722.D488..0	9500	7087	740	1000				50571	22939
6SR32722.D520..0	10000	7460	779	1000				51363	23298
6SR32722.D522..0	11000	8206	857	1000				52884	23988
6SR32722.D524..0	12000	8952	935	1000				55833	25325
6SR32722.C526..0	13000	9698	1013	1250				57219	25954
6SR32722.C528..0	14000	10444	1091	1250				57890	26258
6SR32722.C530..0	15000	11190	1169	1250				59195	26850
6SR32722.C532..0	16000	11936	1246	1250				60453	27421
6SR32722.E534..0	17000	12682	1324	1375				61669	27973
6SR32722.E536..0	18000	13428	1341	1375				62885	28524

1) The typical motor current and the power data in hp and KW are approximate values only; these have been calculated for operation with induction motors and for typical power factor $\cos \phi$ of 88% and motor efficiency of 95.2%

2) Outline Drawing number

3) Certain options will change drive dimensions, for more details see outline page

7.2/8.0 kV motor voltage, 18 cell configuration

Drive Series	Shaft Output ¹⁾		Motor Current ¹⁾	Cell Rating	Dimensions ^{2,3)}		Weight		
	Hp	kW			A	WxHxD		lb	kg
			in	mm					
6SR32723.D480..0	8000	5968	571	1000	382x115x70	9690x2921x1778	M	52361	23751
6SR32723.D485..0	8500	6341	607	1000				53209	24135
6SR32723.D487..0	9000	6714	643	1000				54032	24508
6SR32723.D488..0	9500	7087	678	1000				54032	24508
6SR32723.D520..0	10000	7460	714	1000				54832	24871
6SR32723.D522..0	11000	8206	786	1000				56731	25733
6SR32723.D524..0	12000	8952	857	1000				57831	26232
6SR32723.D526..0	13000	9698	928	1000				61030	27683
6SR32723.D528..0	14000	10444	1000	1000	386x125x76	9792x3175x1930	M	61708	27990
6SR32723.C530..0	15000	11190	1071	1250	394x140x84	9995x3556x2134	M	63026	28588
6SR32723.C532..0	16000	11936	1143	1250				64296	29164
6SR32723.C534..0	17000	12682	1214	1250				65524	29721
6SR32723.E536..0	18000	13428	1285	1375				66713	30260
6SR32723.E538..0	19000	14174	1357	1375				67295	30524
6SR32723.E540..0	20000	14920	1285	1375				67876	30788

10/11 kV motor voltage, 24 cell configuration

Drive Series	Shaft Output ¹⁾		Motor Current ¹⁾	Cell Rating	Dimensions ^{2,3)}		Weight		
	Hp	kW			A	WxHxD		lb	kg
			in	mm					
6SR32725.D520..0	10000	7460	514	1000	437x125x76	11100x3175x1931	N	61763	28015
6SR32725.D522..0	11000	8206	566	1000				63328	28725
6SR32725.D524..0	12000	8952	617	1000				64819	29401
6SR32725.D526..0	13000	9698	668	1000				66244	30048
6SR32725.D528..0	14000	10444	720	1000				66936	30362
6SR32725.D530..0	15000	11190	771	1000	445x140x84	11303x3556x2134	N	68278	30970
6SR32725.D532..0	16000	11936	823	1000				69573	31558
6SR32725.D534..0	17000	12682	874	1000				70824	32125
6SR32725.D536..0	18000	13428	925	1000				74437	33764
6SR32725.D538..0	19000	14174	977	1000				75030	34033
6SR32725.C540..0	20000	14920	1028	1250	450x154x90	11430x3912x2286	N	76190	34559
6SR32725.C542..0	21000	15666	1080	1250				77319	35071
6SR32725.C544..0	22000	16412	1131	1250				78420	35571
6SR32725.C546..0	23000	17158	1183	1250				79493	36057
6SR32725.C548..0	24000	17904	1234	1250				80542	36533
6SR32725.E550..0	25000	18650	1285	1375				81658	37899
6SR32725.C552..0	26000	19396	1215	1250				82573	38355
6SR32725.C554..0	27000	20142	1261	1375				83557	38801
6SR32725.C556..0	28000	20888	1243	1250				83557	38801
6SR32725.E558..0	29000	21634	1288	1375				84522	39239
6SR32725.E562..0	31000	23126	1251	1375				4)	4)
6SR32725.E566..0	33000	24618	1332	1375				4)	4)
6SR32725.E568..0	34000	25354	1372	1375				4)	4)

- 1) The specifications for the typical motor current and the power data are approximate values only; these have been calculated for operation with induction motors and for typical power factor $\cos \phi$ of 88% and motor efficiency of 95.2% , power 28,000 HP and above is calculated for synchronous motor with typical power factor $\cos \phi$ of 100% and motor efficiency of 97%
- 2) Outline Drawing number
- 3) Certain options will change drive dimensions, for more details see outline page
- 4) Please contact your Siemens sales partner.

Water-cooled dimension drawings

Drawing M represents a standard SINAMICS PERFECT HARMONY GH180 water-cooled drive layout: transformer cabinet, followed by cell cabinet, control section, output section and 48" standard cooling cabinet. The only difference will be number of cells: the drawing below shows 15 cell drive with 5 sections; 9 cell drive will only have 3 sections while 24 cell configuration will have 8 sections in the cell cabinet.

There are options that will impact the dimensions of the GH180 water-cooled. The list of options includes:

- A30 touchscreen with standard cable (HMI)
- A80 12 channel RTD
- E01 Exciter furnished by Siemens
- K20 signal lamp in the cabinet door
- K21 display instruments for voltage, current and speed
- G89 controlled outgoing feeder for auxiliaries (3-phase)
- A83 Multilin 869 motor protection relay standalone option
- A82 SEL 710 motor protection relay standalone option
- E04 additional customer analog, digital inputs and outputs (I/O) modules
- L09 Output Reactor where needed
- L53 UPS
- L85 redundant control power
- W32 advanced cooling cabinet

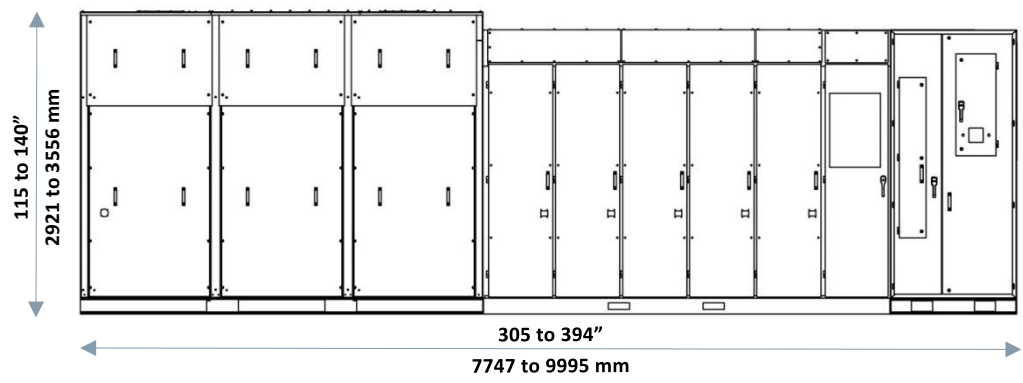

Frame M, 9 to 18 cell, 4000 to 20000 HP, 1000 to 1375 A

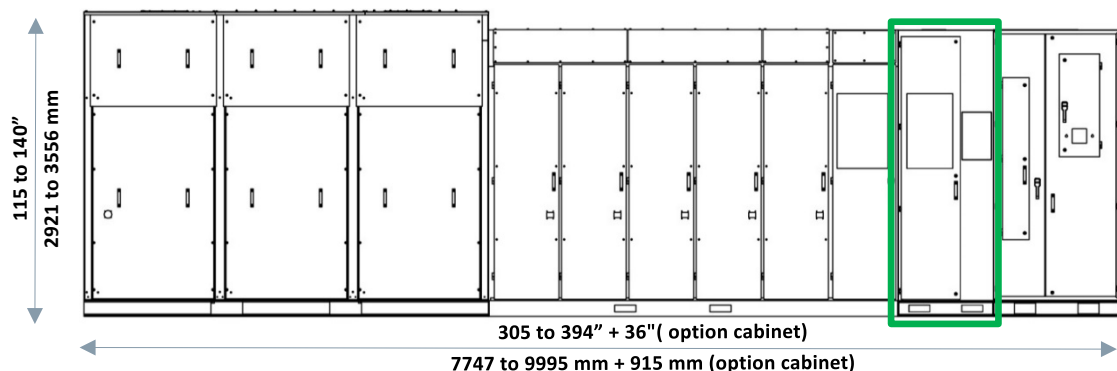

Frame M, 9 to 18 cell, 4000 to 20000 HP, 1000 to 1375 A (example with 36" option cabinet)

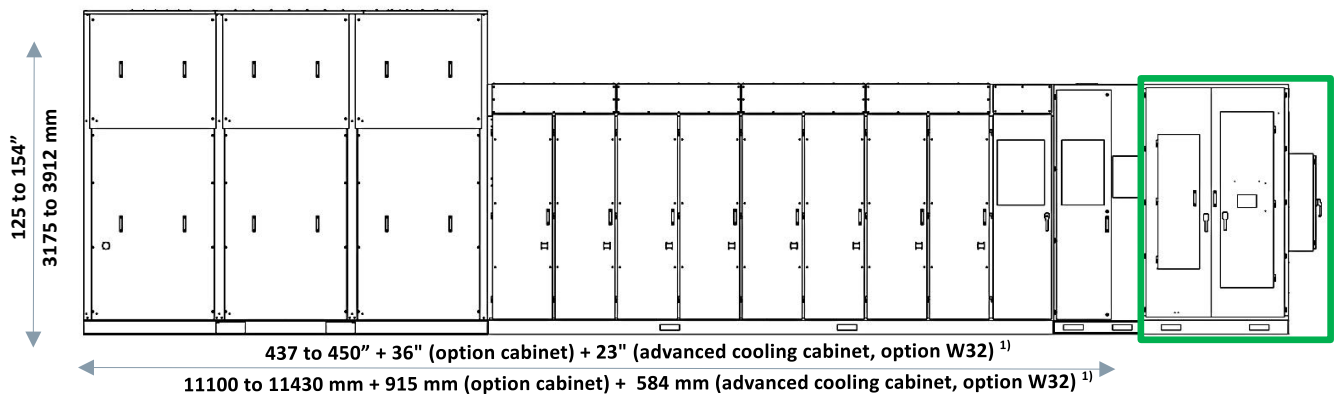

Frame N, 24 cell, 10000 to 33000 HP, 1000 to 1375 A (example with 36" option cabinet, 60" cooling cabinet and control box of the external liquid-to-air heat exchanger)

1) Note: The standard configuration uses an 48" cooling cabinet. With option W32 (60" advanced cooling cabinet), add 23" to the overall cabinet width incl. additional 11" control box on the side.

Engineering information

Control performance

Speed and torque control

Feature	V/Hz control	Open-loop vector control	Closed-loop vector control
Speed range (for 100 % torque and 150 % starting torque)	40:1	100:1	200:1
Torque regulation (% of rated)	n/a	±2 %	±2 %
Torque linearity (% of rated)	n/a	±5 %	< ±5 %
Torque response ¹⁾	n/a	> 750 rad/s	> 750 rad/s
Speed regulation (% of rated)	Motor slip	±0.5 % ²⁾	±0.1 % ^{3,4)}
Speed response ⁵⁾	20 rad/s	20 rad/s	> 20 rad/s ⁶⁾

1) Torque response values are valid for drive without an output filter. Tuning may be required to achieve these values.

2) Approx. 0.3 % speed error is typical. Worst-case speed error is equal to approximately 30 % of rated motor slip.

3) 0.1 % can be achieved with a 1024 PPR encoder. Speed accuracy depends on the encoder PPR.

4) For specific applications, 0.01 % accuracy can be achieved – contact your Siemens sales partner.

5) Speed response numbers apply as long as torque limit is not reached.

6) Testing is required to determine exact value.

Note: Applications that require lower than 1 % speed operation under high load torque should use the CLVC mode. In such cases it is preferable to select a motor that has high full-load slip (> 1.0 %) and high breakdown torque.

Voltage sag, undervoltage conditions and interruptions performance

At full speed, SINAMICS PERFECT HARMONY GH180 provides regular operation for dips down to 90% of nominal voltage. After that the drive output power is rolled-back linearly from 100 % power at 90 % of input voltage down to 50 % power at 66 % of nominal input voltage. Output power is reduced by limiting the available motor torque. The drive can operate continuously in this mode.

When the input voltage falls below 66 %, then the power is quickly reduced to a slightly negative value (regenerative limit, see Figure 22). This limit forces the drive to absorb power from the motor and maintain the DC bus voltages in case the input voltage recovers during medium voltage ride-through. The limit is implemented as an inverse function of speed in order to maintain constant power flow to the DC-bus.

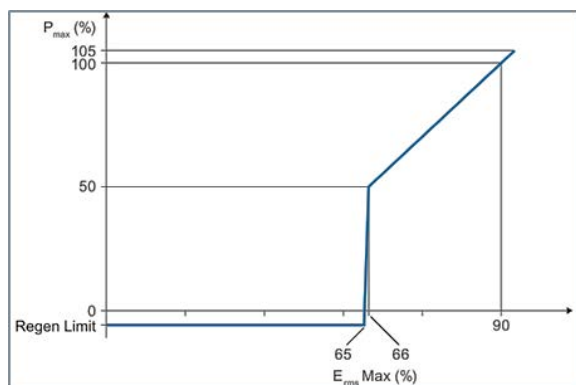

Figure 22: Drive power (P_{max}) as a function of input voltage magnitude (E_{rms})

When the input voltage falls below 66 % (or other limit defined by manufacturer), the drive will ride-through without tripping up to 500 milliseconds with all cells functioning and 100 milliseconds with cells in bypass. During ride-through the motor voltage is maintained but no torque is produced until the input voltage is re-established. The drive provides only magnetizing current to a motor leaving energy stored in the DC link to generate output voltage. Automatic restart into spinning load is possible with no load or line disturbance as long as the motor flux is present.

SINAMICS PERFECT HARMONY GH180 requires a separate low voltage input for control and auxiliaries provided by the customer that is typically backed up by UPS. In the case where a UPS is not available the GH180 drive has the option to incorporate a UPS into the drive design to ensure smooth performance during voltage sag and undervoltage conditions for low voltage network. Without UPS, the SINAMICS PERFECT HARMONY GH180 control ride-through is 5 cycles.

Applications with very low inertia like ESP might come to a complete stop during power loss ride-through and require either automatic or manual restart depending on operator preferences.

NXGPro/NXGPro+ ToolSuite

The NXGPro/NXGPro+ ToolSuite is a PC-based high-level Graphical User Interface application that integrates various software tools used for NXGPro/NXGPro+ based drives. ToolSuite, equipped with the Microsoft Windows Operating System, allows navigation through a drive's features by using a PC or by using a touch- screen allowing customer to monitor and control drive's functions quickly and easily. ToolSuite contains the following tools: Drive Tool, Debug Tool, and SOP Utilities.

Configuration

- Multilevel password to limit access: the same password used as in drive
- Folders for each drive configuration category (i.e., VFD menu system)
 - Icon colors to indicate default and modified parameter values
 - On screen parameter identifier (matches operator panel IDs for speed menus)
 - Parameter editing assisted by minimum/maximum limits and defaults
- Ability to upload logs, parameters, system program
- Ability to download system program and/or configuration data files

Graphing

- Adjustable time scale
- Predefined variable list to select variable to be graphed
- Graph up to 10 variables
- Individual variable offsets
- Customizable graphics: fonts, color, styles
- Freeze graphics
- Freeze graph on fault
- Freeze on selectable trigger
- Zoom graph
- Printable and exportable graphics

Status

- Programmable display variables
- Pick list selectable variables, same as drive operator panel display list. The drive control provides the capability to monitor up to 64 different drive and motor parameters according to customer application and specification. They can be selected from more than 200 parameters and variables available in the system. The table below shows some of the parameters available.
- First 4 synchronized to operator panel display
- Fault and alarm indicators (traffic lights: red = fault, yellow = alarm, green = none)

Drive Tool

Its purpose is to manage all of the drive features and provide the user with a user-friendly view of the drive. The Drive Tool's main features include:

- Drive configuration
- Drive variable graphing
- Drive status (provides real time status of various parameters, measured values, and calculations)

Debug Tool

This application provides a remote graphical user interface. With the Debug Tool, the user can examine drive variables using a PC in a simple and quick manner. The debug utility is intended for use during test, commissioning, and troubleshooting of the drive.

SOP Utilities

The System Operating Program (SOP) is the logic that maps the internal and external I/O into the functionality of the drive. In its simplest form, it just maps internal states to external points. It performs most of the functionality on the PC running the ToolSuite, it also offers serial communications capability for uploading and downloading the System Program directly to the drive via an Ethernet interface between the drive and the PC.

Input parameters	Motor parameters	Drive parameters
Input voltage	Output power (kW)	Transformer overload
Input voltage harmonics (one at a time)	Output energy kW-Hr	VFD efficiency
Input current	Output current – RMS	Drive State
Input current harmonics (one at a time)	Output voltage – RMS	Drive Internal Losses
Input power factor	Motor torque	Power Cell Status
Input power (kW)	Motor speed (RPM)	Bypass status
Input reactive power (kVAR)	Motor slip (%)	Auxiliary Demand
Input kW-Hr	Drive output frequency (Hz)	Output of energy saver
Input phase sequence	Magnetizing current	High starting torque mode state
Loss of phase	Torque current	Drive neutral voltage
Low voltage	Motor flux	Max available output voltage
	Stator resistance	Synchronous transfer state
	Full load speed	Critical speed avoidance output

Protection and monitoring functions

Vector control	The drive can be controlled by means of vector control algorithm without an encoder: open-loop control (standard) or with it: closed-loop control (option).
Auto tuning	Auto tuning is available to optimize the control performance of the drive.
Automatic restart	Automatic restart is a custom feature used to purposely restart and restore the drive operation after a power failure or power removal. When Automatic Restart function is specified by the customer, qualified Siemens personnel must configure and ensure the function executes as specified.
Energy saver	<p>Energy saver control allows the reduction of motor losses, and improves overall efficiency, when the demanded motor load is low. Depending on the motor load, the control will reduce motor flux.</p> <p>As motor load increases, the control will increase motor flux.</p>
Flying restart	The flying restart function permits smooth connection of the drive to a rotating motor.
Diagnostics functions	<ul style="list-style-type: none"> • Self-diagnosis of control hardware • Non-volatile memory for reliable diagnosis when the power supply fails • Monitoring of IGBTs with individual messages for each cell • User-friendly local operator panel with plain text messages • The alarm/fault log consists of a circular buffer that records up to 256 faults or alarms, so that customer can access the most recent faults and/or alarms that have been detected • The historic log records operating data of the drive and is frozen upon detection of a fault
User configurable digital meters	The user can select indication of speed, voltage, current, input/output power, and efficiency on the operator panel.
Operating hours and switching cycle counter	<p>The amount of time that the drive was operational since it was commissioned can be displayed.</p> <p>The switching cycle counter can be generated by means of an event log from the drive controller.</p>
Detection of actual motor speed	The control algorithm calculates actual motor speed from currents and voltages measured at the drive output.
Emergency stop button	The drives are equipped as standard with an Emergency Stop button (red mushroom button with yellow collar) which is fitted in the cabinet door. The contacts of the pushbutton are connected in parallel to the terminal block so they can be integrated in a protection concept on the plant side.
Ground fault protection	An optional output signal can be provided to operate the customer protection.
I/O monitoring	I/O signals allow user customization of the system and they can be monitored remotely or by using the operator panel display.
Thermal overload protection	Based on the output signals of the drive, the thermal motor model is calculated. The motor thermal overload protection algorithm prevents the motor from being exposed to excessive temperatures.

Interfaces

Air-Cooled SINAMICS PERFECT HARMONY GH180 drives offer digital and analog input and output capabilities. Please note, for specific options and applications additional input and output modules can be added (Option E04 or E06).

The following tables provide an overview of the pre-assignment function of interfaces in the standard versions of the air-cooled drives.

Signal type	Total Quantity	Configuration
Digital inputs	20	24 V DC or 120 V AC
Digital outputs	16	Dry form C contacts, rated 250 V AC at 1 A or 30 V DC at 1 A
Analog inputs	3	4 ... 20 mA or 0 ... 10 V DC
Analog outputs	2	4 ... 20 mA

Digital inputs	
0a	Remote inhibit (NC)
1a	Remote start
2a	Remote stop (NC)
3a	Fault reset
0b	Off select
1b	Remote or auto select (K31-34)
2b	Start push b(K29)
3b	Stop push button (K29)
0c	Output reactor over-temperature alarm or MPM alarm (if option selected) (I09)
1c	Reactor over-temperature trip alarm or MPM trip (if option selected)
2c	Aux voltage monitor relay feedback – loss of 3Ø control
3c	Transformer over-temperature alarm (NC)
0d	Transformer over-temperature trip alarm (NC)
1d	Blower 1 TOL feedback O.K.
2d	Blower 2 TOL feedback O.K.
3d	Blower 3 TOL feedback O.K.
0e	Blower 4 TOL feedback O.K.
1e	Blower 5 TOL feedback O.K.
2e	Blower 6 TOL feedback O.K.
3e	Latch fault relay feedback
Digital outputs	
0	Drive control in local at VFD
1	Drive ready to run
2	Drive running
3	Drive alarm
4	Drive fault (NO)
5	ProToPS process alarm active (if option selected)
6	ProToPS trip alarm active (if option selected)
7	Motor heater control
8	Blower 1 starter
9	Blower 2 starter
10	Blower 3 starter
11	Blower 4 starter
12	Blower 5 starter
13	Blower 6 starter
14	Reserved
15	Latch fault relay set output
Analog inputs	
1	Speed reference (default), 4 ... 20 mA
2	Auxiliary speed reference (default)
3	Reserved (default)
Analog outputs	
1	Motor speed (default)
2	Motor torque (default)

Air cooling requirements

Power losses of drive system

Traditional way to publish heat losses for a VFD is based on the drive's efficiency – heat rejection of the drive itself or

$$kW.PowerLoss = (100 \% - DriveEfficiency) \times kW.DrivePower$$

The limitation of this approach is incorrect sizing of the VFD at full load resulting in less current required by the motor – potentially starving the motor at full load. That is why Siemens uses system approach and includes not only VFD efficiency but also motor efficiency when calculating losses for the drive:

$$kW.PowerLoss = kW.Input - kW.Output$$

This ensures that a customer can not only get properly size HVAC but also properly sized drive. Typical motor efficiency used to calculate heat losses in the tables below is 95.2 %.

Air-cooled drives rely on circulating air to cool the components within the drive. The amount of heat generated is equivalent to the drive losses. As the drives take in as much air as is output, no building make-up air is required unless the drive has the option "drive prepared for duct flange connection" (M64 or M68), in this instance depending on your site and building configuration, Siemens will provide the required airflow and pressure drop to ensure proper drive function.

Drive series	Shaft output		w/ copper transformer		w/ aluminum transformer ¹⁾	
	hp	kW	kW	BTU/h	kW	BTU/h
6SR5	150	112	4.3	14,541	4.9	16,705
6SR5	200	149	5.7	19,388	6.5	22,273
6SR5	300	224	8.5	29,081	9.8	33,409
6SR5	400	298	11.4	38,775	13.1	44,545
6SR5	500	373	14.2	48,469	16.3	55,682
6SR5	600	447	17.0	58,163	19.6	66,818
6SR5	700	522	19.9	67,857	22.8	77,954
6SR5	800	597	22.7	77,551	26.1	89,091
6SR5	900	671	25.6	87,244	29.4	100,227
6SR5	1000	746	28.4	96,938	32.6	111,364
6SR5	1100	820	31.3	106,632	35.9	122,500
6SR5	1250	932	35.5	121,173	40.8	139,204
6SR5	1500	1119	42.6	145,407	49.0	167,045
6SR5	1750	1305	49.7	169,642	57.1	194,886
6SR5	2000	1491	56.8	193,876	65.3	222,727
6SR5	2250	1678	63.9	218,111	73.4	250,568
6SR5	2500	1864	71.0	242,346	81.6	278,409
6SR5	3000	2237	85.2	290,815	97.9	334,091
6SR5	3500	2610	99.4	339,284	114.2	389,772
6SR5	4000	2983	113.6	387,753	130.5	445,454
6SR5	4500	3356	127.8	436,222	146.9	501,136
6SR5	5000	3729	142.0	484,691	163.2	556,818
6SR5	5500	4101	156.3	533,160	179.5	612,500
6SR5	6000	4474	170.5	581,629	195.8	668,181
6SR5	6500	4847	184.7	630,098	212.1	723,863
6SR5	7000	5220	169.6	578,631	198.9	678,568
6SR5	8000	5966	193.8	661,293	227.3	775,506
6SR5	9000	6711	218.0	743,954	255.7	872,444
6SR5	10000	7457	242.3	826,616	284.1	969,382
6SR5	11000	8203	266.5	909,278	312.5	1,066,320
6SR5	12000	8948	290.7	991,939	340.9	1,163,259
6SR5	13000	9694	314.9	1,074,601	369.3	1,260,197
6SR5	14000	10440	339.2	1,157,262	397.7	1,357,135
6SR5	15000	11186	363.4	1,239,924	426.1	1,454,073
6SR5	16000	11931	387.6	1,322,586	454.6	1,551,011
6SR5	17000	12677	411.8	1,405,247	483.0	1,647,950

1) Transformer efficiency at 4500 hp and above is the same for both copper and aluminum transformers

Water cooling requirements

Drive with integral liquid-to-liquid heat exchanger

SINAMICS PERFECT HARMONY GH180 6SR327 as a default is offered with an integral plate and frame heat exchanger. This heat exchanger consists of a series of thin, corrugated plates, spaced with rubber gaskets, to transfer heat between two fluids. This type of heat exchanger is very efficient because the fluids are exposed to the entire surface area of the plates. This is the best option if customer has water available on site.

Liquid-to-liquid heat exchanger data:

- Made of stainless steel alloy 304 or 316.
- Customer inlet water temperature: 32 - 104F (0-40C)
- Heat exchanger design pressure – 150 psi (1034.2 kPa)

The raw water must be chemically neutral, clean and free of solids. Additional specifications relating to the quality of the raw water are listed in the following table.

Variable	Specified value
Grain size of any entrained parts	< 0.5 mm
pH value	6.5 to 8.0
Carbonate hardness	< 0.9 mMol/l (5 °dH)
Total hardness	< 1.7 mMol/l (9.5 °dH)
Chlorides	< 60 mg/l
Sulfates	< 80 mg/l
Nitrates	< 10 mg/l
Iron (Fe)	< 0.2 mg/l
Ammonia	< 10 mg/l
Dissolved substances	< 3.4 mMol/l (340 ppm)

In case of deviations it is recommended to carry out an analysis of the water in order to ensure the heat exchanger's endurance strength. If the water is supplied from a lake or river, W55 option is recommended for 6SR327 – prepare for inlet water filter or specify a shell and tube heat exchanger. This is a drop ship option.

Customer Water Connections Interface: customer is responsible for water connection to the drive:

- SINAMICS PERFECT HARMONY GH180 6SR327 - 2" ANSI flange (DIN 50 flange)

Cold Side Flow Requirements for GH180 6SR327 with integral liquid-to-liquid heat exchanger:

- 9 cell – 100 GPM (378.5 LPM)
- 12 cell – 150 GPM (567.8 LPM)
- 15 cell – 200 GPM (757.1 LPM)
- 18 cell – 225 GPM (851.7 LPM)
- 24 cell – 275 GPM (1,041 LPM)

Example of an integral liquid-to-liquid heat exchanger:



Below is an example of the flow diagram:

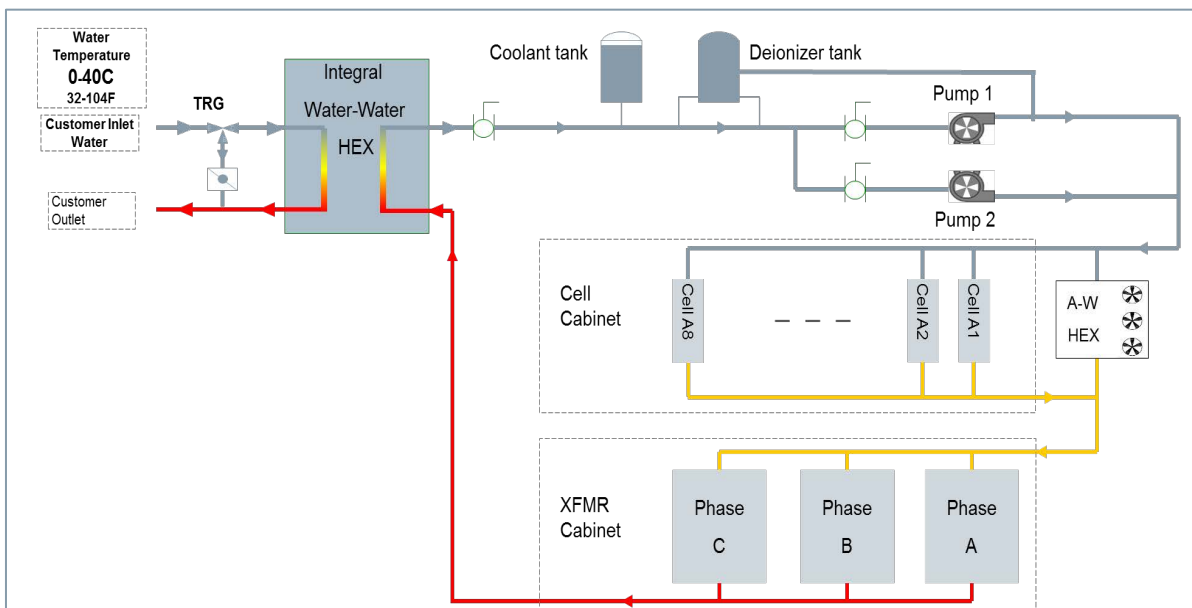

Drive prepared for liquid-to-air heat exchanger

When water is not available on site SINAMICS PERFECT HARMONY GH180 6SR327 has an option to be installed with external liquid-to-air heat exchanger (W32). In this case, integral heat exchanger is removed from the circuit and replaced with set up to directly connect to external heat exchanger.

In this set up the coolant flows through the system, collecting the heat that has dissipated from the power cells and transformer, and then exits the drive, passing through the heat exchanger. As the coolant passes through the external tubing (coil) of the heat exchanger, it is cooled by a network of blowers, blowing cooler air onto the coils and reducing its temperature by means of forced convection.

Each heat exchanger fan motor has a non-fused disconnect mounted on the heat exchanger unit. The contactors for each of the fans are located inside the converter heat exchanger control panel. A separate auxiliary feed is required to the converter that powers all of the contactors.

The heat exchanger is designed to operate with standard capacity fans. There are several options available for heat exchanger: additional capacity (N+1) as an option and the heat exchanger copper coil can be coated with Heresite to protect the cooling coils from corrosion. It can be designed to be vertical or horizontal air flow. Shown below is a horizontal heat exchanger design and its installation.



Below is an example of the flow diagram:

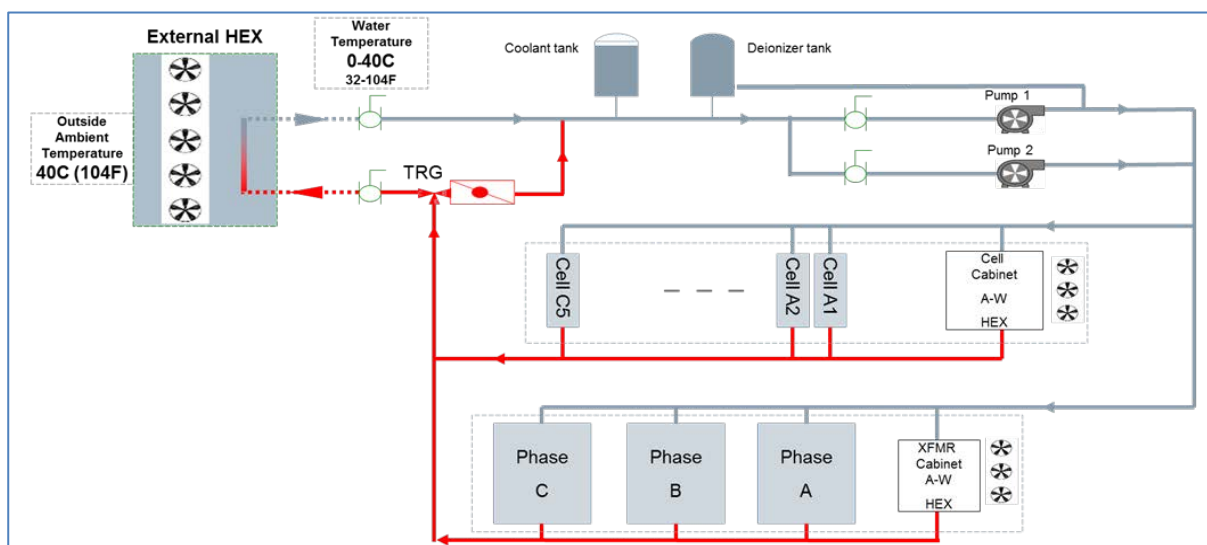

6SR327 with W32 Option flow requirement:

The flow rate depends on customer site and conditions - it is impacted by installation distance, size of the pipe and other conditions. As long as the pressure drop external to the VFD coolant cabinet is less than 15 psi (103.4 kPa) and the heat exchanger is at or below the VFD elevation, the coolant system should operate as designed.

Customer Water Connections Interface: customer is responsible for water connection to the drive

- GH180 6SR327 W32 – 3" ANSI flange (DIN 80 flange)

When installing external heat exchanger, it is recommended to evaluate if you need freeze protection. When freeze protection is not required 100 % deionized water is recommended. If freeze protection is required glycol should be limited to the range of 25 to 60 % by volume.

Freezing point of coolant	% Propylene glycol by volume (by mass)
+10 °F / -12.2 °C	25 (25)
0 °F / -17.8 °C	32 (33)
-10 °F / -23.3 °C	39 (40)
-20 °F / -28.9 °C	44 (45)
-30 °F / -34.4 °C	48 (49)
-40 °F / -40.0 °C	52 (53)
-50 °F / -45.6 °C	55 (56)
-55 °F / -48.0 °C	60 (62)

The volume of coolant required for the drive is approximately 100 U.S. gallons. To determine the total system volume, the volume in the piping to and from the main heat exchanger and the volume of the main heat exchanger must be determined by the customer. A drive in the system with total volume < 250 U.S. gallons can operate with one coolant expansion tank. A drive in a system with total volume between 250 and 500 U.S. gallons requires one high capacity coolant expansion tank.

Current product information

You can find current information on SINAMICS PERFECT HARMONY GH180 in the Portal: portal.innomotics.com

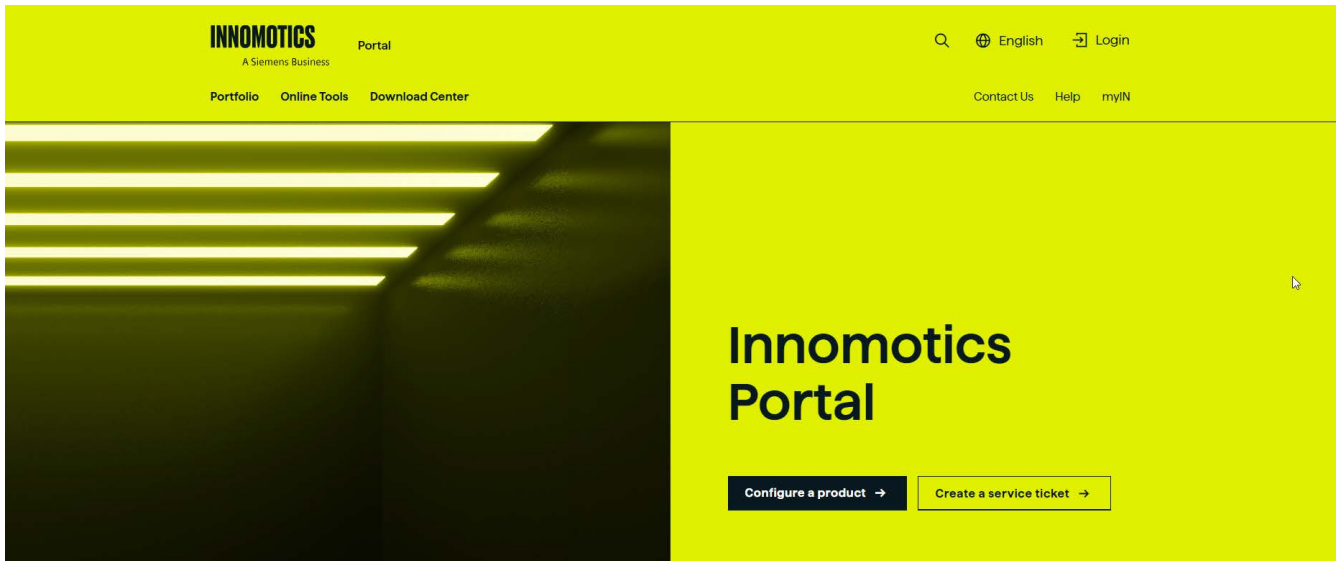

Siemens Product Configurator and other engineering tools

The Drives Technology Configurator is the entry point when it comes to configuring high-voltage motors and medium-voltage converters. It supports you when selecting options and provides all of the relevant technical data sheets and dimension drawings.

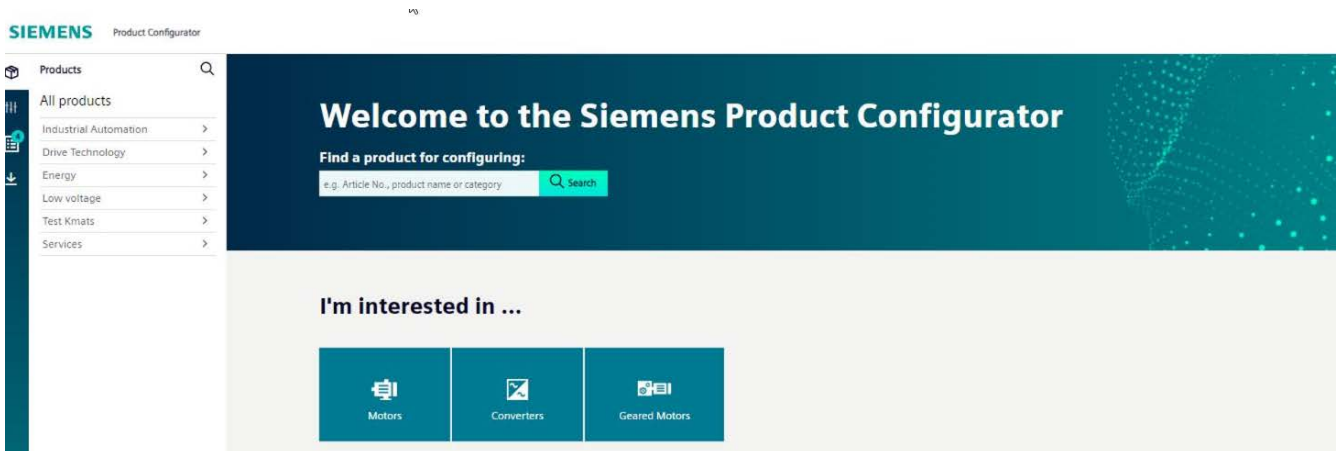

Tools information and access

- Siemens Product Configurator: siemens.com/spc
- Selection and Configuration website : innomotics.com/en/services/selection-configuration

Services



Keep your business running and shape your digital future – with Services for Large Drives Applications

Optimizing the productivity of your equipment and operations can be a challenge, especially with constantly changing market conditions. Working with our service experts makes it easier. We understand your industry's unique processes and provide the services needed so that you can better achieve your business goals.

You can count on us to maximize your uptime and minimize your downtime, increasing your operations' productivity and reliability. When your operations have to be changed quickly to meet a new demand or business opportunity, our services give you the flexibility to adapt.

We assist in keeping your operations as energy and resource efficient as possible and reducing your total cost of ownership. As a trendsetter, we ensure that you can capitalize on the opportunities of digitalization and by applying data analytics to enhance decision making: You can be sure that your plant reaches its full potential and retains this over the longer lifespan.

You can rely on our highly dedicated team of engineers, technicians and specialists to deliver the services you need – safely, professionally and in compliance with all regulations. We are there for you, where you need us, when you need us.

innomotics.com/services

Portfolio overview

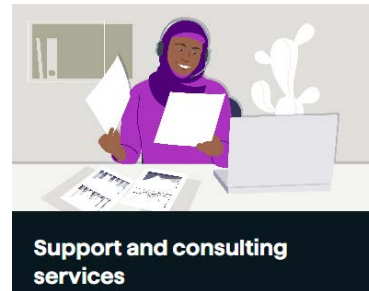

Support and consulting services

Our **LDA Portal** delivers comprehensive information, application examples, FAQs and support requests: portal.innomotics.com

Technical Support and Diagnostic: Advice and answers for all inquiries about functionality, handling, and fault clearance.

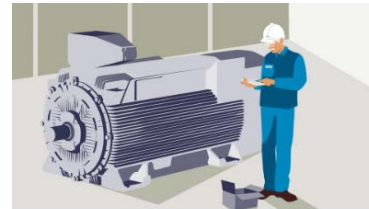

Field and maintenance services

A worldwide network of specially trained service personnel provides you with a highly quality service and an optimized commissioning time. By making use of a regular inspection and health check, you can maximize the availability of your plant and optimize your production processes.



Repair services

Repair Services are offered on-site and in regional repair centers for fast restoration of faulty devices' functionality. Also available are extended repair services, which include additional diagnostic and repair measures, as well as emergency services.



Spare parts services

Spare Parts Services are available worldwide for smooth and fast supply of spare parts – and thus optimal plant availability. Genuine spare parts are available for up to ten years. Logistic experts take care of procurement, transport, custom clearance, storage and order management. Reliable logistics processes ensure that components reach their destination as fast as needed.

Since not all spare parts can be kept in stock at all times, Siemens offers a preventive measure for spare parts provisioning on the customer's premises with optimized **Spare Parts Packages** for individual products, custom-assembled drive components and entire integrated drive trains – including risk consulting.

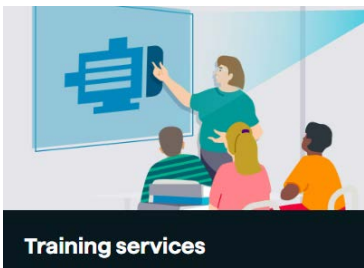

Training services

From the basics and advanced to specialist skills, **LDA training** courses provide expertise right from the manufacturer – and encompass the entire spectrum of Siemens LDA products and systems for the industry. Courses are offered at various locations as well as online.



Retrofit and Upgrade Services

Use Siemens **Retrofit Services** to extend the lifetime of your machinery and plants. Optimize the availability, reliability and energy efficiency of your installed motors and drives by retrofitting existing products and systems.

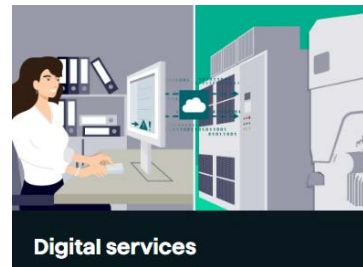

Digital services

To provide you with optimum support in your work, we have put together two digital service packages as part of our digital offering SIDRIVE IQ. The first package, **SIDRIVE IQ Rapid Response**, is all about getting your equipment up and running again as quickly as possible. The second package, **SIDRIVE IQ Guided Supervision**, is a service package specifically for continuous monitoring.

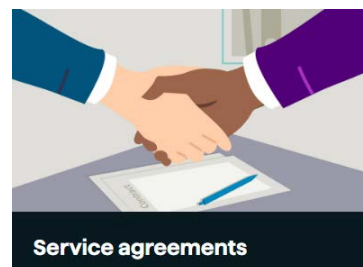

Service agreements

A **Service Agreement** enables you to easily bundle a wide range of services into a single annual or multiyear agreement. You pick the services you need to match your unique requirements or fill gaps in your organization's maintenance capabilities. Programs and agreements can be customized as KPI-based and/or performance-based contracts.

SIDRIVE IQ

Get more out of your drive systems with SIDRIVE IQ



Drive systems play a key role in countless production processes and are ultimately what keeps the entire production going. Faults or failures involving components like motors and drives have costly consequences. Avoiding these faults by taking timely and deliberate action requires intelligent transparency – which allows for measures like targeted, proactive, and well-timed maintenance.

The future is digital – especially in the industrial sector. Thanks to digitalization and networked processes, companies can produce more flexibly and reliably, and they can respond to events more rapidly. Digitally enhanced drive components are an important step toward digitalized automation. With SIDRIVE IQ, you can now benefit from an Industrial Internet of Things (IIoT) digitalization solution for drive systems. Take advantage of digitalization to enter a new dimension of availability, serviceability, productivity and efficiency.

Reap the fruits of digitalization for medium voltage drives and high voltage motors with SIDRIVE IQ. The trinity of smart products, optimized plant designs and services provides you, with the insights you need, to make proactive choices you can trust – every single time.

With our **smart products** and systems with edge-capability you are able to make drive systems an “Industrial IoT platform device” for interoperability with automation and application.



Our **digital platform** gives you the perfect integration in IIoT ecosystems through modularity, scalability and connectivity with data model and processing libraries and functional user interaction and experience. Increase availability, optimize your asset management and processes for faster decision-making and a boost of productivity.

Digital **Services** by SIDRIVE IQ is the cloud-based approach for the next generation of remote and condition monitoring services. With SIDRIVE IQ, condition data from the drive train components is transferred to the cloud and analyzed by our service experts.

SIDRIVE IQ – our holistic solution and service to IIoT for your drive systems.

innomotics.com/sidrive-iq

SIDRIVE IQ helps you to:

-  **Boost your productivity**
-  **Reduce service and maintenance costs**
-  **Increase availability**
-  **Shorten unplanned downtimes**

Scope of supply

The standard scope of delivery of the SINAMICS PERFECT HARMONY GH180 includes:

- Input section
- Transformer section
- Cell section
- Control section
- Output section

The basic unit of each SINAMICS PERFECT HARMONY GH180 Water-cooled product line consists of the following:

- Input section
- Transformer cabinet section
- Cell cabinet section
- Control section
- Output section
- If liquid-to-liquid heat exchanger is selected: coolant cabinet section comes with integral water-to-water heat exchanger

SINAMICS PERFECT HARMONY GH180 6SR327 liquid-to-air heat exchanger is delivered and located separately.

The water-cooled drive coolant cabinet is delivered without deionized water.

The necessary pipes and connection pieces from converter coolant system to raw-water supply on the plant side are not included in the scope of supply.

Input and output cables are not included in the scope of supply.

Accessories

Cell lifter

The power cells of SINAMICS PERFECT HARMONY GH180 drives can be replaced as a unit. To replace, the entire power cell must be removed from the drive and transported on a cell lifter. Appropriate cell lifters are available.

Some cell lifters can be used to replace blowers as well. Please, contact your Siemens sales partner for more details.

Recommended list of spare parts

Spare Part Packages ensure that a customer has necessary components to deal with emergencies. These packages are recommended but not required. The components within the kits will vary depending on drive generation and cooling method.

Each manufacturing location identifies components that meet their customers base requirements. For more details about available spares contact your Siemens Service Representative.

Below is the list of spare part packages recommended for GH180:

Basic spare parts package list

Description	Quantity
Power Cell	1
NXG Control Box (DCR)	1
System Interface Board	1
User I/O Board	1
Cell Fiber Optic Kit	1

Below is an example of the advanced spare parts package with some of the components included in it. This package is typically sold after the equipment is commissioned or at any time during drive operating life. For more complete list contact your Siemens Service Representative.

Air-cooled advanced spare parts package list

Description	Quantity
Control (NXG) Power Supply	1
Keypad	1
Fuses	
Blower and Blower Accessories	1
Bypass Contactor	1
Bypass Power Supply Fuse	1
Bypass Control Board	1

Water-cooled advanced package spare parts list

Description	Quantity
Control (NXG) Power Supply	1
Keypad	1
Fuses	
Pump and Pump Accesories	1
Bypass Contactor	1
Bypass Power Supply Fuse	1
Bypass Control Board	1

Get more information

SINAMICS Drives:
[siemens.com/sinamics](https://www.siemens.com/sinamics)

SINAMICS PERFECT HARMONY GH180:
[innomotics.com/sinamics-perfect-harmony-gh180](https://www.innomotics.com/sinamics-perfect-harmony-gh180)

Published by
Innomotics GmbH

Innomotics GmbH
Vogelweiherstr. 1-15
90441 Nuernberg
Germany

Produced in Germany
© Innomotics GmbH 2023

Subject to changes and errors. The information given in this document only contains general descriptions and/or performance features which may not always specifically reflect those described, or which may undergo modification in the course of further development of the products. The requested performance features are binding only when they are expressly agreed upon in the concluded contract.

All product designations may be trademarks or other rights of Siemens AG, its affiliated companies or other companies whose use by third parties for their own purposes could violate the rights of the respective owner.

Security information

Siemens provides products and solutions with industrial security functions that support the secure operation of plants, systems, machines and networks.

In order to protect plants, systems, machines and networks against cyber threats, it is necessary to implement – and continuously maintain – a holistic, state-of-the-art industrial security concept. Siemens' products and solutions constitute one element of such a concept.

Customers are responsible for preventing unauthorized access to their plants, systems, machines and networks. Such systems, machines and components should only be connected to an enterprise network or the internet if and to the extent such a connection is necessary and only when appropriate security measures (e.g. firewalls and/or network segmentation) are in place.

For additional information on industrial security measures that may be implemented, please visit
<https://www.siemens.com/industrialsecurity>

Siemens' products and solutions undergo continuous development to make them more secure. Siemens strongly recommends that product updates are applied as soon as they are available and that the latest product versions are used. Use of product versions that are no longer supported, and failure to apply the latest updates may increase customer's exposure to cyber threats.

To stay informed about product updates, subscribe to the Siemens Industrial Security RSS Feed under
<https://www.siemens.com/cert>